

Key digital®

DIGITAL SIGNAGE



CORPORATE



LARGE VENUE



EDUCATION



HEALTHCARE



HOUSE OF WORSHIP



BAR & RESTAURANT



E-SPORTS



Q4 2019 PRODUCT CATALOG

Interactive Content: click on product SKU to jump to its page

Control Systems & Software

› Compass Control® Pro System	
› KD-ProCL1/4/6/8	1
› Compass Control® Pro App	2
› Compass Alliance™ Partners	2
› Compass Navigator™	2
› Compass Control® Pro Partner Modules	2
› Market Solutions	3-5
› Master Controller	
› KD-MC1000	6
› Control Interface & Converters	
› KD-CX800	7
› KD-CCXR200	8
› Product Access & Control Software & Apps	
› Key Digital® iOS App	9
› Key Digital® Management Software™ Pro (KDMS™ Pro)	10
› Key Digital® Management Software™ (KDMS™)	11

AV Over IP Solutions

› 4K UHD AV Over IP Systems	
› KD-IP1022ENC	12
› KD-IP1022DEC	13
› KD-IP922ENC	14
› KD-IP922DEC	15
› KD-IP822ENC	16
› KD-IP822DEC	17
› 1080p HDMI Over IP Systems	
› KD-IP1080Tx	18
› KD-IP1080Rx	18

Presentation Solutions

› 4K/18G Presentation Switchers	
› KD-UPS52U	19
› KD-PS42	20
› 4K/18G POH/HDBT Wallplate Switchers/Extenders	
› KD-X4x1WUTx	21
› KD-X2x1WDTx	22
› KD-X2x1WVTx	23
› 4K/18G POH/HDBT Extenders	
› KD-X100MRx	24
› KD-X40MRx	25
› PTZ USB Camera	
› KD-CAMUSB	26

Digital Signage

› Video Wall Seamless Presentation Matrix Switchers	
› KD-VW4x4Pro	27
› POH/HDBaseT/HDMI MultiView Seamless Presentation Matrix Switchers	
› KD-MLV4x2Pro	28

Matrix Switchers

› 4K HDBaseT/HDMI Matrix Switchers with DSP	
› KD-Pro8x8D	29
› 4K/18G HDMI Matrix Switchers with Independent Audio Switching	
› KD-MS4x4G	30
› KD-MS8x8G	31

HDMI Switchers

› 4K/18G HDMI Switchers with Audio De-Embedding, IP Control	
› KD-Pro2x1X	32
› KD-Pro4x1X	33

› 4K/18G HDMI Switchers with Audio De-Embedding	
› KD-Pro2x1	34
› KD-Pro4x1	35
› 4K/18G Ultra-Slim HDMI Switchers with Audio De-Embedding	
› KD-S2x1X	36
› KD-S4x1X	37
› 4K/18G Ultra-Slim HDMI Switchers	
› KD-S2x1	38
› KD-S4x1	39

HDMI Distribution Amplifiers

› 4K/18G POH/HDBT/HDMI Distribution Amplifiers/Switchers	
› KD-DA2x4G	40
› KD-DA2x8G	41
› 4K/18G Ultra-Slim HDMI Distribution Amplifiers with Audio De-Embedding	
› KD-DA1x2X	42
› KD-DA1x4X	43
› 4K/18G Ultra-Slim HDMI Distribution Amplifiers	
› KD-DA1x2	44
› KD-DA1x4	45
› KD-DA1x8	46

HDMI Extenders

› 4K/18G HDMI Fixers, Extenders and Buffers	
› KD-FIX418A	47
› KD-FIX418	48
› 4K HDMI Extenders, Boosters and Buffers	
› KD-HDFIX22	49

HDBaseT/HDMI Extenders

› 4K HDMI/VGA Wall-plate Switchers, Scalers, and HDBaseT Extenders	
› KD-SX440WP	50
› 4K/18G/444/60Hz HDBaseT/POH Extenders	
› KD-X444L	51
› KD-X444S	52
› 4K HDBaseT/HDMI Extenders with Audio De-Embedding	
› KD-X422POA	53
› 4K HDBaseT/HDMI Extenders	
› KD-X222PO	54

Video Converters and Scalers

› Video Converter and Scaler	
› KD-VCS500	55

Audio Solutions

› Audio Matrix Switchers with DSP	
› KD-MAX8x8	56
› Digital Audio Amplifiers	
› KD-AMP220	57

HDMI Cables

› Commercial-Grade HDMI Cables	
› 4K/18G Commercial-Grade HDMI Cables – VW1 UL Rated	58
› 4K/18G Commercial-Grade HDMI Cables – CL3/FT4 UL Rated	59
› Plenum Active Optical HDMI Fiber Cables	
› 4K@60Hz/18G/444 Plenum Active Optical HDMI Fiber Cables	60

About Key Digital®

› Encompass360™ Program	61
› System Design Group (SDG™)	62
› Key Digital® Training	63
› Innovation Timeline	64
› Contacting Key Digital®	65

CORPORATE



E-SPORTS



DIGITAL SIGNAGE



EDUCATION



HEALTHCARE



HOUSE OF WORSHIP



BAR & RESTAURANT



LARGE VENUE

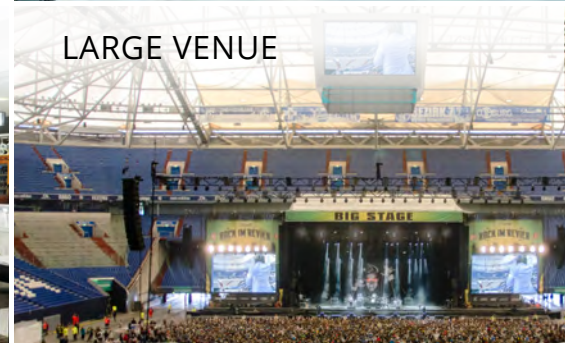

Compass Control® Pro is a fully integrated iOS-based control system. Now with Pre-Built Templates and Compass Alliance™ Partners Bi-Directional Modules.

Enterprise Software License

KD-ProCL1

1 Unit

KD-ProCL4

4 Units

KD-ProCL6

6 Units

KD-ProCL8

8 Units

Enterprise Software License for Compass Control® Pro

KEY FEATURES

- Required for activation of Compass Control® Pro System on iOS
- Marries with Device ID of each iOS or Android device
- Allows unique GUI creation for different devices across single project
- Transferable between devices
- Enables project upload and storage to/from Compass Control® cloud
- Provides **FREE** access to Compass Navigator™ PC Editor for fast and easy system programming
- **FREE** Technical Support for C1 Certified Installers / Programmers

Thank you for Purchasing Compass Control® Pro

Compass Control® Pro is a fully integrated control system designed to use iOS and Android devices as its backbone.



- KD-ProCL1
- KD-ProCL4
- KD-ProCL6
- KD-ProCL8

Enterprise Software License
for Compass Control® Pro

Supports iOS & Android

*Prior to purchasing Compass Control Pro products all resellers must complete C1 Compass Control Pro Certification Training. Key Digital highly recommends that all resellers use 3rd party Compass Control Pro Master Programmers to program the system.



Compass Control® Pro App

Compass Control® Pro Demo App - FREE Download on the App Store - **DOWNLOAD DEMO TODAY!**

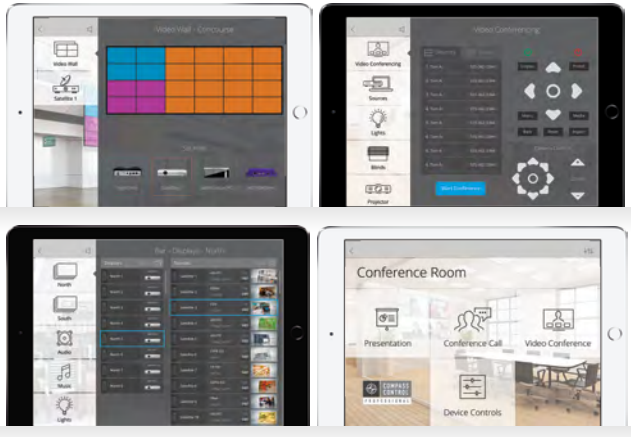

- FREE Full Featured Demo for Customer Presentations - Great sales tool!
- Multiple Demo options showcase full system capabilities
- Replaces all of remotes and traditional control interfaces with one device
- Fully programmable with Compass Navigator™
- Customize and install full App on customer device
- Use KD-ProCL1/4/6/8 software licence to make live controller

Compass Navigator™

PC Software for Compass Control® Pro System Programming



- System Programming: Allows fast and easy programming of the Compass Control® Pro system and connected devices
- Flexibility: Allows for both basic and complex level programming
- Advanced Programming: Create unique and powerful custom control interfaces through advanced programming
- Ease of Setup: Comes complete with additional IR/RS-232/TCP/IP modules

Compass Alliance™ Partners

Instantly integrate third party components from Compass Alliance™ Partners



- Plug and play: Easily build a working integrated system with products from any of our partners.

Compass Control® Pro Partner Modules

Custom-built bi-directional drivers and GUI modules for Compass Alliance™ Partner products and software



- Simplicity of Integration: Easily integrate any of our partner products into any Compass Control® Pro environment via Compass Navigator™

Market Solutions

www.keydigital.com/compass

CORPORATE



SOLUTION EXAMPLE: CONFERENCE ROOMS

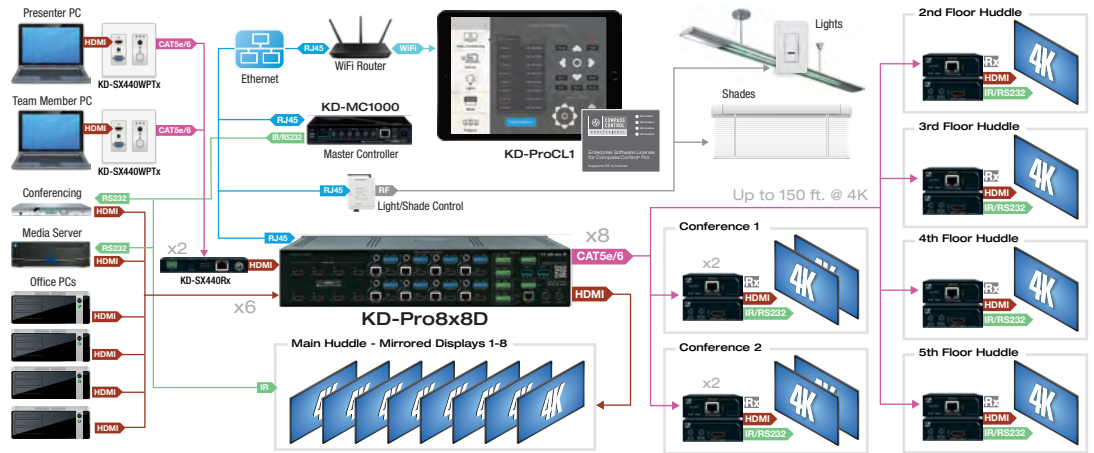

DIGITAL SIGNAGE



SOLUTION EXAMPLE: VIDEO WALLS

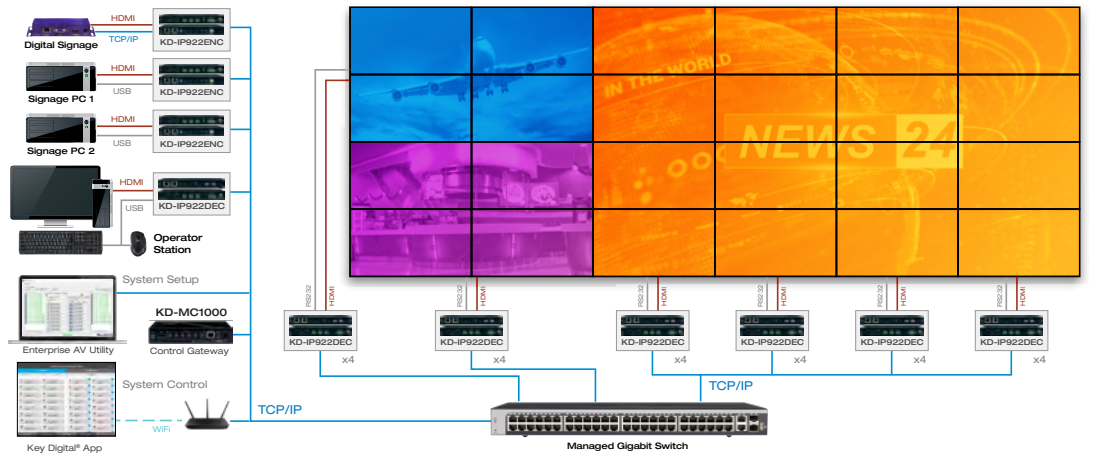

BAR & RESTAURANT



SOLUTION EXAMPLE: BAR/RESTAURANT

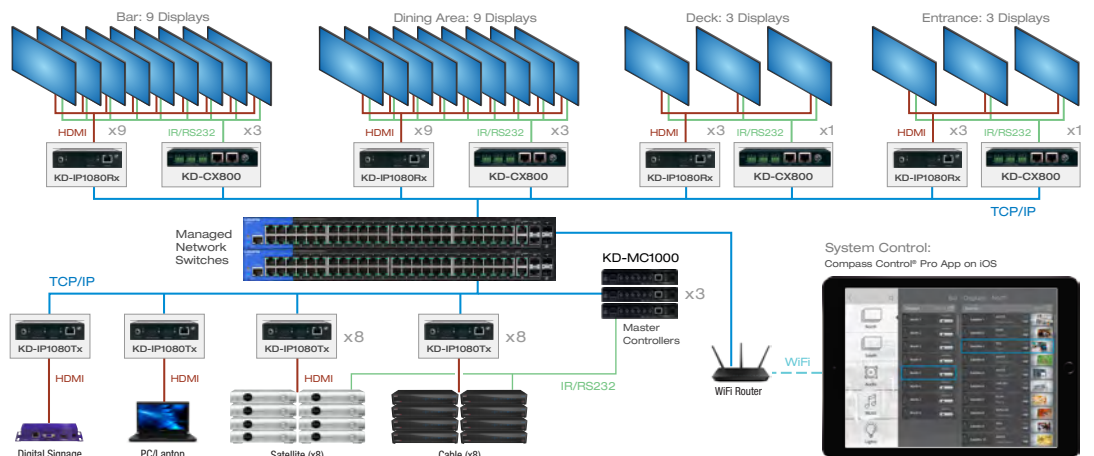

Market Solutions

www.keydigital.com/compass

HOUSE OF WORSHIP

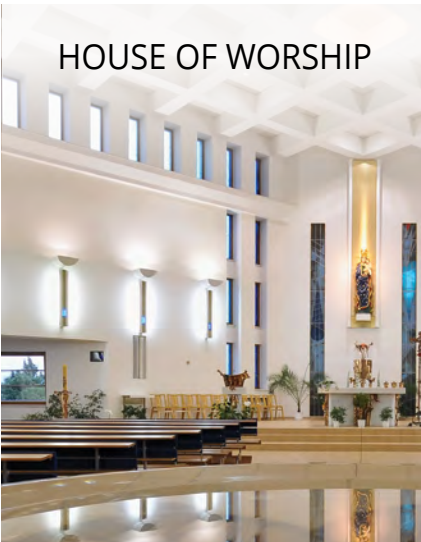

SOLUTION EXAMPLE: WORSHIP CENTER

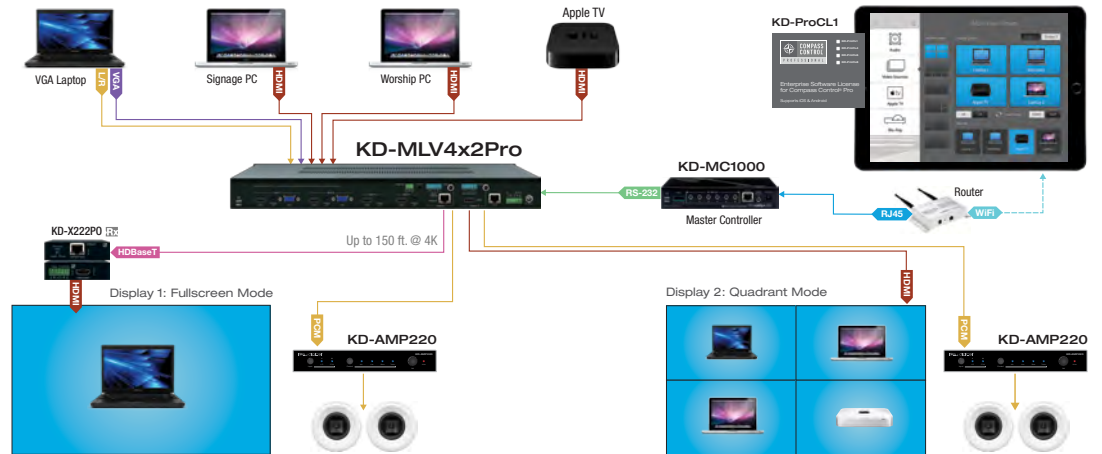

EDUCATION



SOLUTION EXAMPLE: CLASSROOM

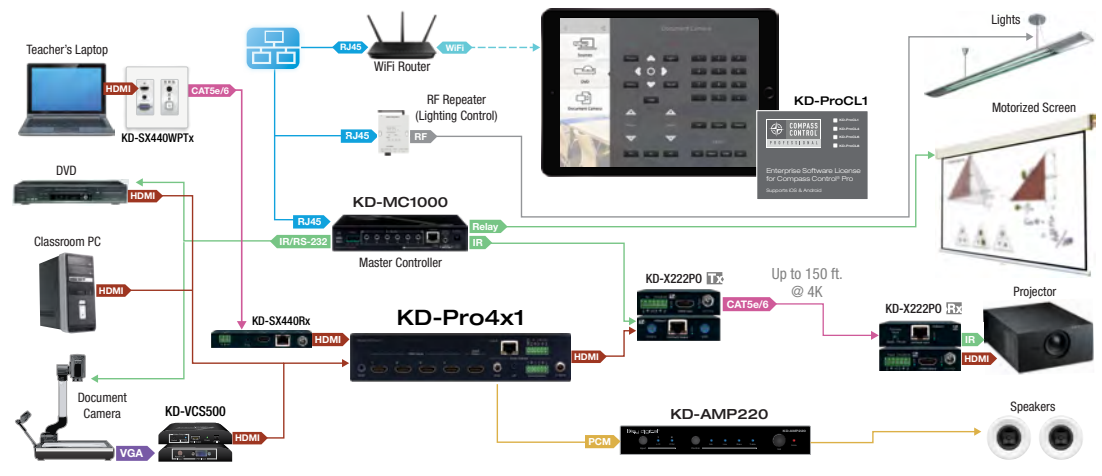

HEALTHCARE



SOLUTION EXAMPLE: COURTROOM

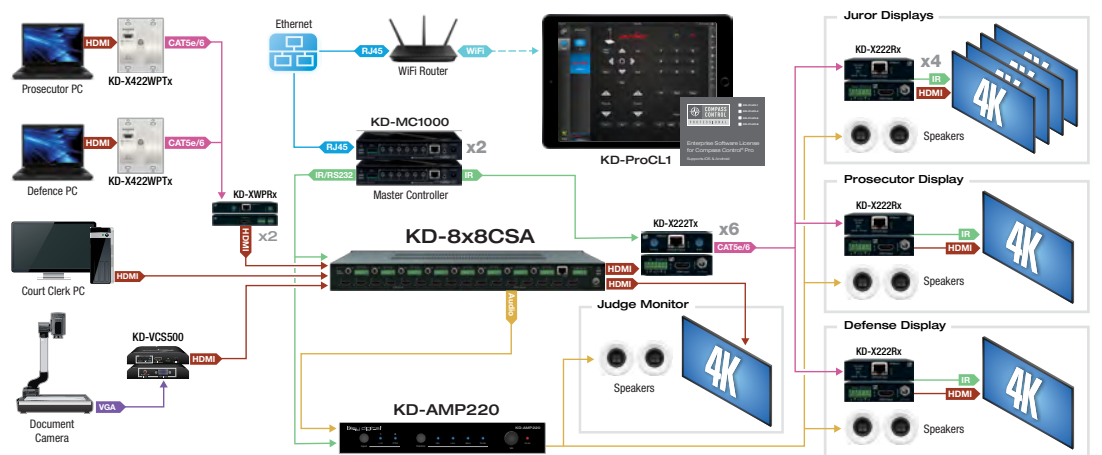

Market Solutions

www.keydigital.com/compass

E-SPORTS

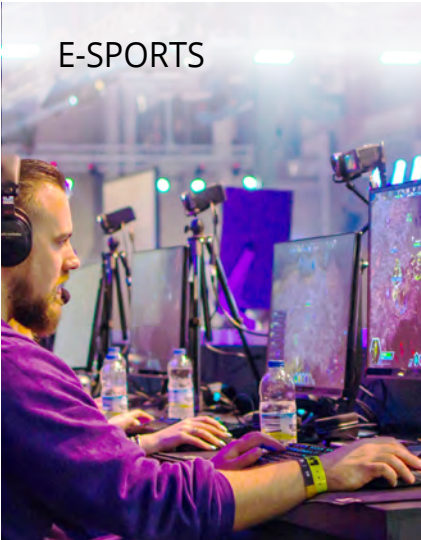

SOLUTION EXAMPLE: E-SPORT TOURNAMENT

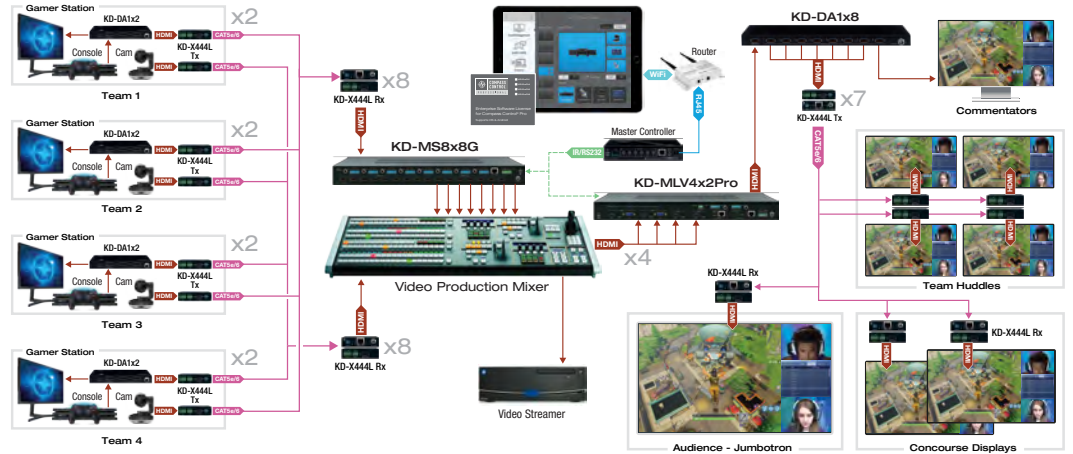

LARGE VENUE



SOLUTION EXAMPLE: IP-ENABLED STADIUM VIDEO SYSTEM

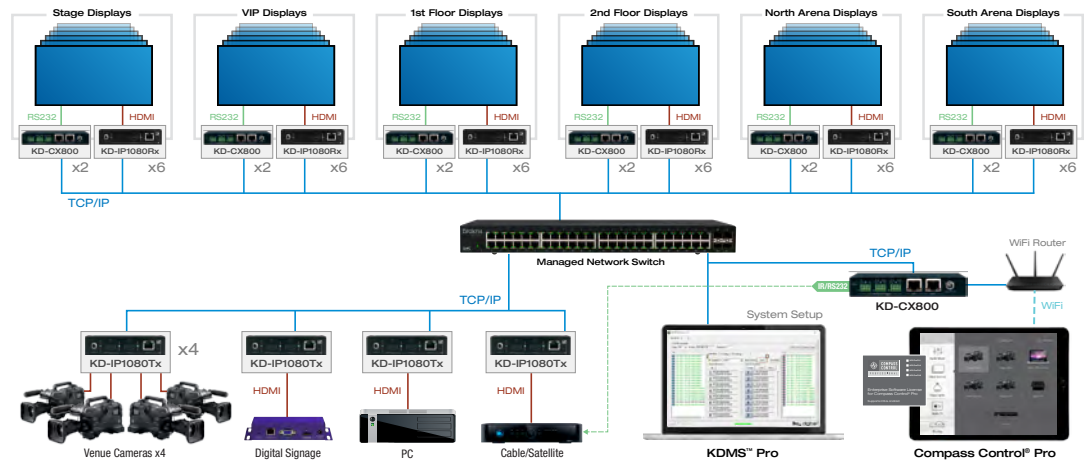

RESIDENTIAL

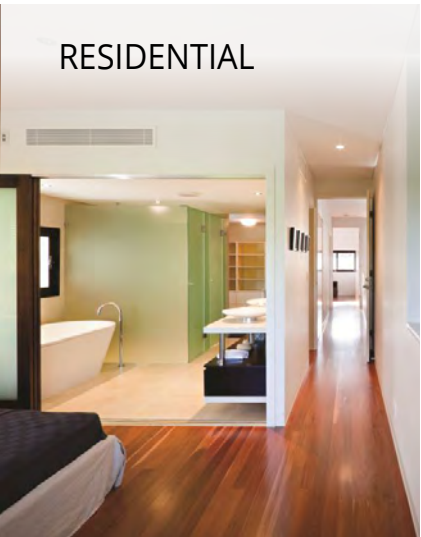

SOLUTION EXAMPLE: RESIDENTIAL SIMULCAST

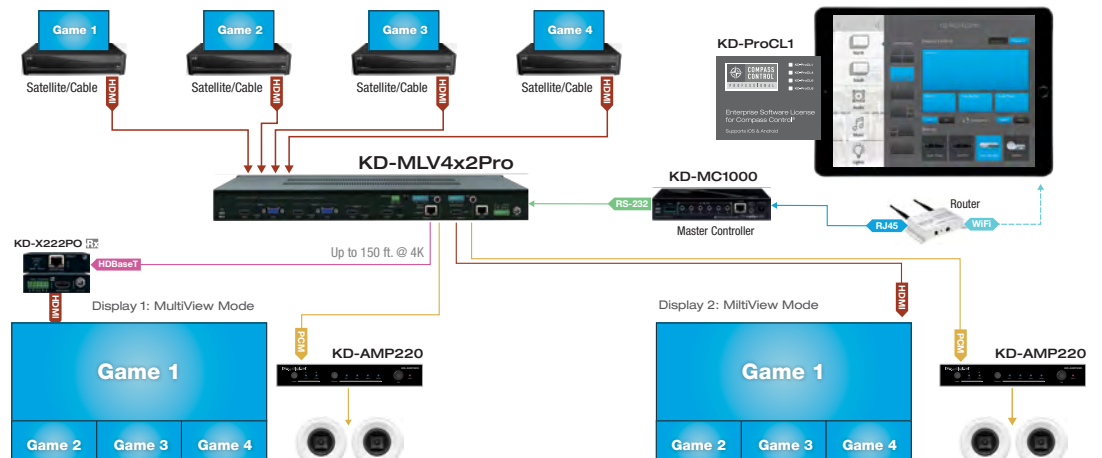

KD-MC1000

Master Controller for Compass Control® Pro (Wired/LAN, supports up to 8 Ports)

KEY FEATURES

- **iOS & Android Backbone:** Fully integrated control system designed to use iOS and Android devices – as its backbone
- **Total 8 Ports:** 6 MCP35™ multi-function I/O Ports, 1 Relay/Contact Closure Port, 1 ZigBee® Wireless Port
 - MCP35™ Multi-function 3.5mm I/O Ports can be programmed to be one of the following functionalities: bi-directional IR, bi-directional RS-232, Voltage Level output, Voltage Sensor input, PCM Audio sensor input or Composite Video Sensor input
- **USB Support:** USB port for firmware upgrades
- **Built-in IR Learning:** Front-facing IR window enables learning of IR codes from external IR remotes
- **LAN:** Direct wire to LAN via RJ45
- **Relay Control:** Control external equipment with one set of switchable contacts. Any multi-function 3.5mm port can be converted to Contact Closure using Key Digital® KD-CCXR200 Converter
- **Real-Time Master Control:** Allows user to store variables and events internally with/without iOS device
- **Compass Navigator™:** PC Editor allows fast and easy programming
- **Device Configuration:** Allows all functions and integration into Compass Control® Project via IP and Compass Navigator™ software
- **Complete System Control:** Audio, Video, Lighting, Shades, HVAC, Security, Climate, Music and more
- **Control Distribution:** Integrates with all Key Digital® Control Routing HDMI Switchers to expand the control system and add control ports
- **No need for PC or Mac in the system:** All system performance is controlled by iOS or Android device and KD-MC1000 Master Controller
- **Compass Alliance™ Partners:** Pre-loaded code sets - [Full Partner Listing](#)



RELIABLE iOS INTEGRATION FEATURES

- **IP Connectivity Stabilizer:** Stable and constant TCP/IP socket created by KD-MC1000 with IP target devices via Telnet or HTTP regardless of iOS devices status.
- **Event Handler:** Scheduled events & actions based on iOS time and calendar variables including:
 - Schedule Mode: Schedule and execute timer events from iOS device and/or KD-MC1000
 - Schedule Sensing Mode: Execute events triggered by voltage or video/audio sensing by KD-MC1000

SPECIFICATIONS

- MCP35™ Multi-Function I/O (6): 3.5mm Female stereo connectors independently configured as IR (mono, Tx or Rx, fixed to +5V), RS-232 (stereo, Tx and Rx, fixed to +5V), Voltage Trigger (fixed to +5V), Voltage Sensor (Digital Audio or Video, from +0.1V to +3.3V)
- Relay (1): Independently configurable to NO (active), or NC (inactive) with 12A / 250VAC resistive switching capacity
- TCP/IP (1): Supports 10/100BaseT up to 100Mbps for communication with iOS devices via LAN, software updates, device configuration and setup
- Accessories: USB Cable, (1) 3-Pin Terminal Block for Relay, (6) 3.5mm to IR Emitter, (3) 3.5mm to RS-232 Data Cable, Rack Mount Ears
- Power Supply: KD-PS5V2A, 5V/2A, 100-240VAC, 50-60Hz, Interchangeable head
- Product: 6.5" x 4" x 1.13", 1.5 lbs. ➤ Packaging: 8.8" x 6.2" x 3.9", Weight: 3 lbs.
- Regulation: CE, RoHS, WEEE, EAC ➤ Enclosure: Black Metal 1/2U

SYSTEM DESIGN EXAMPLE

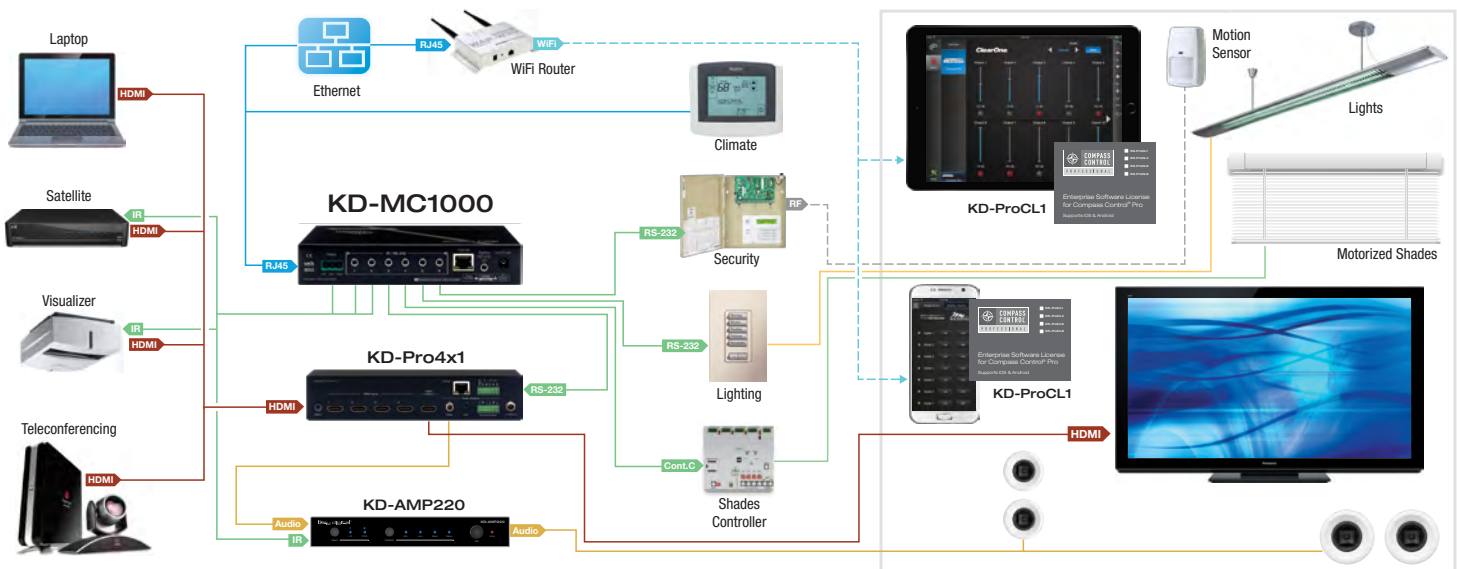

KD-CX800

Control Interface with IR and RS-232 Over IP Routing

KEY FEATURES

KD-CX800 is very flexible, with four supported modes of use:

► Mode 1: Control gateway for Enterprise AV Over IP system

- Enables more third-party control options than other HD Over IP systems
- Accepts commands from third-party control systems or Compass Control®
- Supports generic RS-232, TCP/IP, and IR Key Digital matrix switching command strings

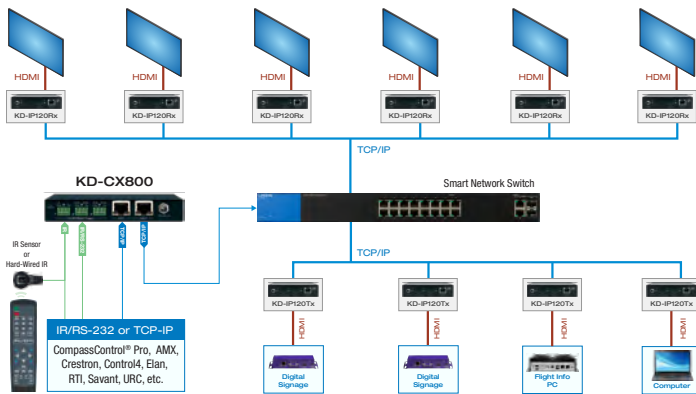

► Mode 2: Compass Control® Master Controller

- Supports communication to/from licensed iOS and Android devices
- Flexible port configuration (IR, RS-232, trigger, sensor) set in Compass Navigator™ program
- IR learner/sensor built-in
- Supports up to two real-time bi-directional RS-232 ports
- TCP/IP device control direct from iOS/Android controller – no ports used

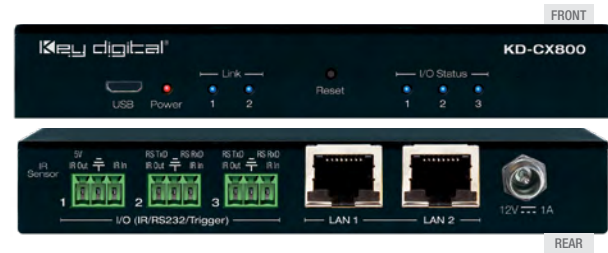
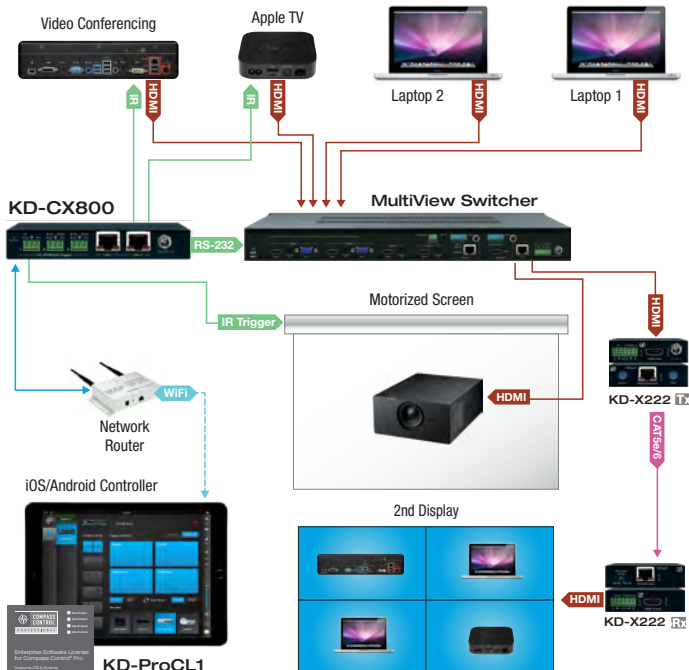

► Mode 3: Third-Party Control via KeyCode Open API

- Cost-effective control expansion with advanced third-party control systems
- Adds reliable hardware interface to network-based control apps
- Enables IR, RS-232, and voltage device control
- Robust API allows for bi-directional communication

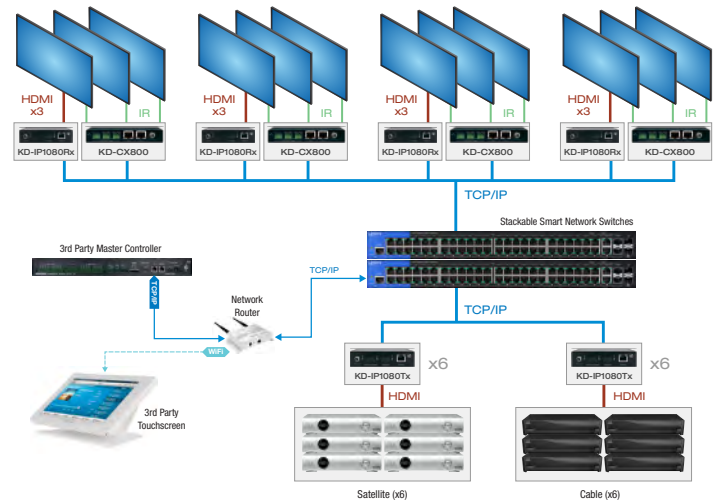

► Mode 4: Control Extension via IP

- Carry any supported combination of IR, RS-232, and voltage triggers over the network
- Extends control signals up to 400 ft. / 121 m. Greater distances possible with adapters.
- Supports systems with or without network switches

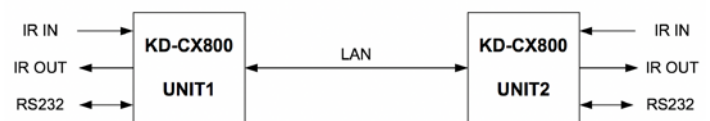

SPECIFICATIONS

- Power Supply: KD-PS12V1ASC, 12V/1A, 100-240VAC, 50-60Hz, Interchangeable head, screw-in connector
- Regulation: CE, RoHS, WEEE, EAC
- Enclosure: Black Metal
- Product Dimensions: 5.06" x 3.08" x 0.78"
- Packaging Dimensions: 5.78" x 4.01" x 3.46"
- Product Weight: 0.5 lb
- Shipping Weight: 1.5 lb

Multi-function I/O Port to Contact Closure/Relay Converter



KD-CCXR200

Converts MCP35™ Multi-function I/O Port to Contact Closure/Relay

KEY FEATURES

- › **Compatible with:** KD-MC1000 Master Controller and HDBaseT/HDMI Matrix Switchers with built-in Compass Control® Pro
- › **Multifunction 3.5mm based Compass Control® Port – MCP35™:** supports following seven features:
 - › 1. IR output
 - › 2. IR Input
 - › 3. RS232 bi-directional
 - › 4. Voltage sensor
 - › 5. Voltage trigger
 - › 6. PCM audio sensor
 - › 7. Composite Video sensor
- › **Converts:** Any I/O Multifunction Compass® Control Port (MCP35™) to Contact Closure/Relay when set to Output Voltage Trigger Mode
- › **Contact Functionality:** Contact Normally Open, if 5V applied – Contact Closed.
- › **3.5mm mono input connection:** Use a male-to-male 3.5mm mono cable from KD-MC1000 Master Controller or HDBaseT/HDMI Matrix Switchers with built-in Compass Control® Pro
- › **One Contact Closure/Relay Output**
- › **Contact Closure Maximum Rating:** 250VAC/5A, 30VDC/5A
- › **Maximum Distances:**
 - › 3.5mm mono cable: 10 feet
 - › Contact Closure/Relay Output with one twisted pair of CAT5e/6 cable: 100 feet
- › **No external power required**



USAGE EXAMPLES

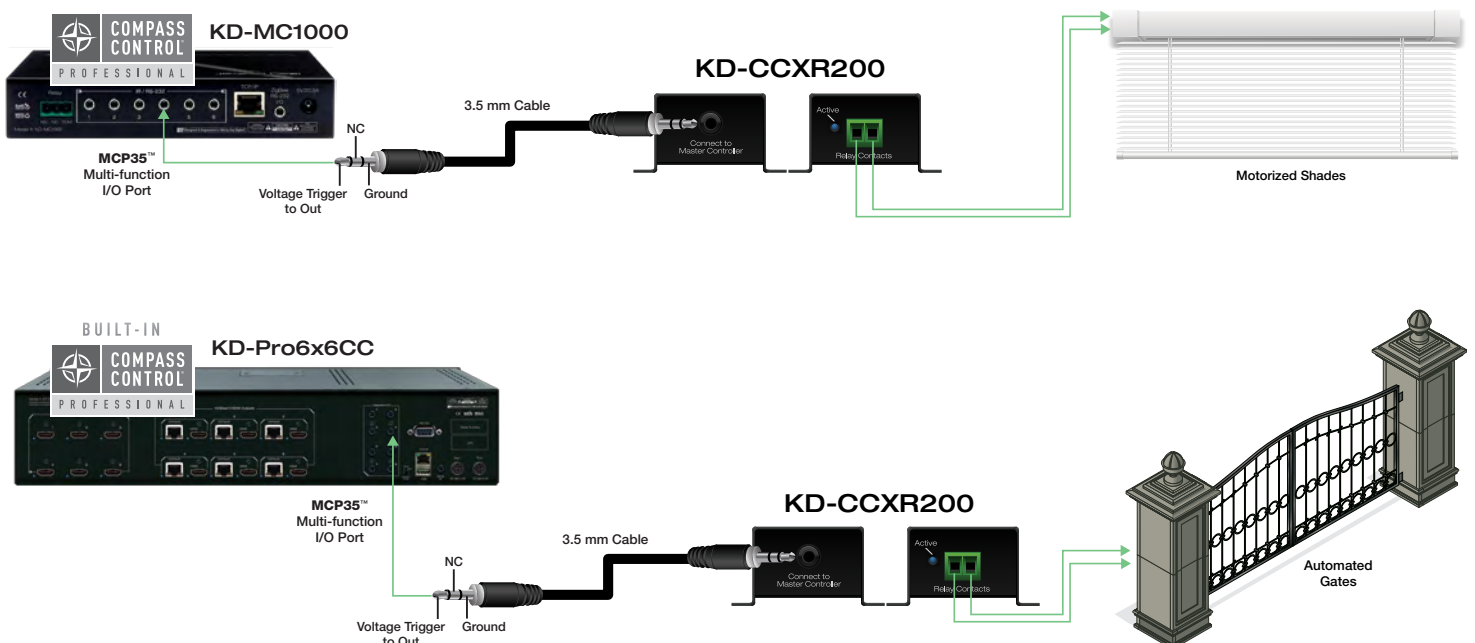

Key Digital® iOS App

Access & Control Key Digital® App Ready products via TCP/IP directly with Key Digital® App.
Control Key Digital® Enterprise AV™ over IP Systems with full switching capabilities.

KEY FEATURES

- **iOS App with Demo Mode:** Download Key Digital® App Demo from the App Store - Demo system can be used as a customer test drive and sales tool
- **IP Control:** All Key Digital® App Ready IP-enabled products are automatically detected on local area network and are ready for control
- **Enterprise AV™ over IP Access:** Easily Access and Control Key Digital® Enterprise AV - Over IP Network Switching & Control Solutions
- **Switcher Control:** Enables users to choose desired video sources and assign them on selected displays
- **MultiView and Video Wall Controls:** Assign sources, modify displays, control bezels and screen modes in our Digital Signage products: KD-MLV4x2Pro and KD-VW4x4Pro
- **Custom Presets:** Create presets that help reduce time spent configuring your A/V system
- **Scan & Connect:** Key Digital® App will scan your network for Key Digital® App Ready products and will connect to them automatically.
- **Available for iPad and iPhone:** [Download Demo App](#)

USER INTERFACE EXAMPLES

Video Wall Switcher

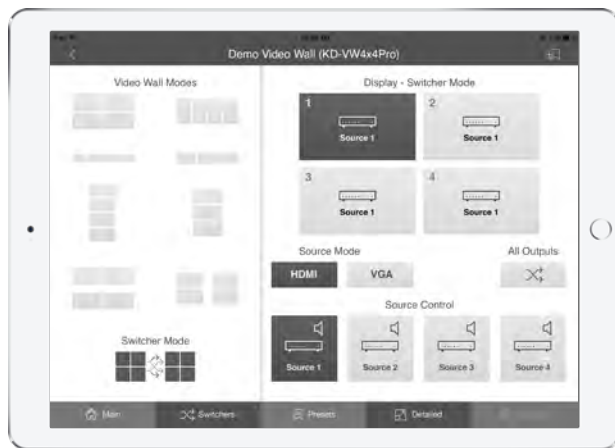

Enterprise AV™ over IP Switcher



iPhone UI



HDMI Matrix Switcher



Presentation Multi-View Switcher

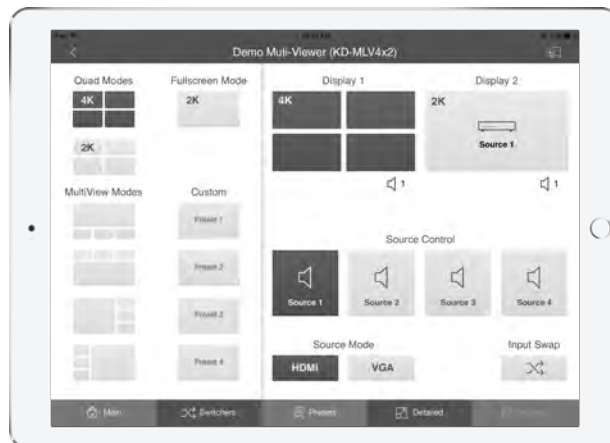

Presets

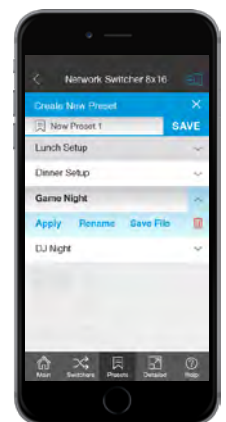

Key Digital® Management Software™ Pro (KDMS™ Pro)

Key Digital unit/system configuration and control PC software - For Professional A/V Integrators

Key digital PRO
MANAGEMENT SOFTWARE™

KEY FEATURES

- PC software
- Professional A/V Integration tool
- Scans and detects via network, USB, and RS-232
- Supports multiple Key Digital units / systems on same network
- Configure compatible Key Digital units and systems
 - » Input / output naming
 - » Network settings
 - » Firmware updates
- Provides pre-built control GUI for compatible Key Digital systems
- Enterprise AV™ over IP solutions unit and virtual matrix configuration
- Manage video and audio routing, volume levels, video walls and more:
 - » Enterprise AV™ over IP System
 - » HDMI and HDBaseT matrix switches
 - » Audio matrix switchers
 - » Presentation switchers
 - » Video wall processors
 - » Multi-viewers

Enterprise AV™ over IP Matrix Switching

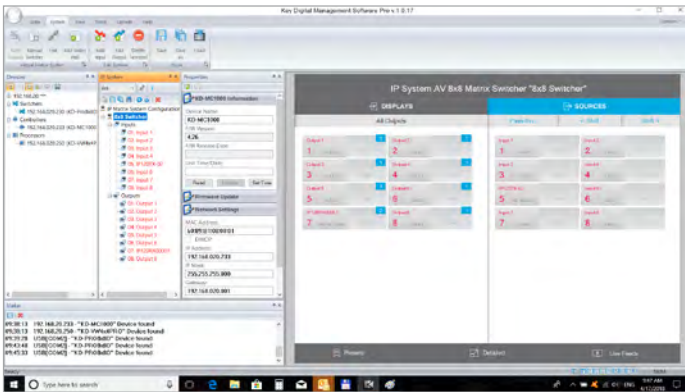

Network Scanning

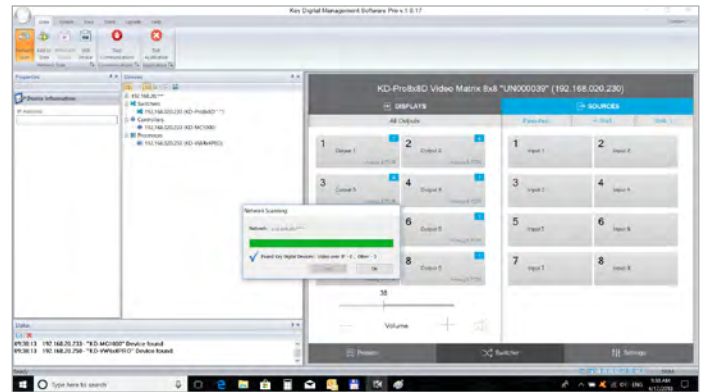

HDBT Matrix Switcher

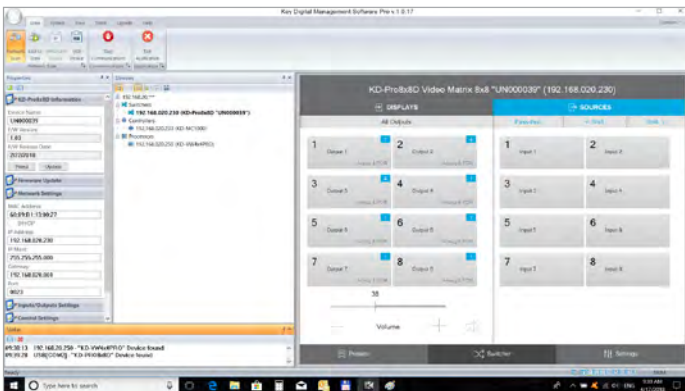

Matrix Audio Setup

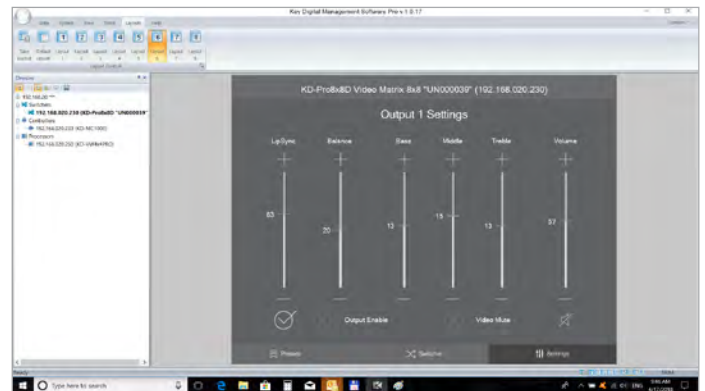

Video Wall Setup - Quad Mode

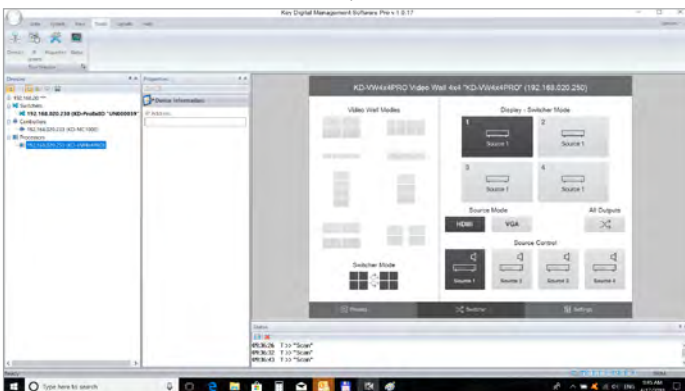

Video Wall Setup - Multi-Display

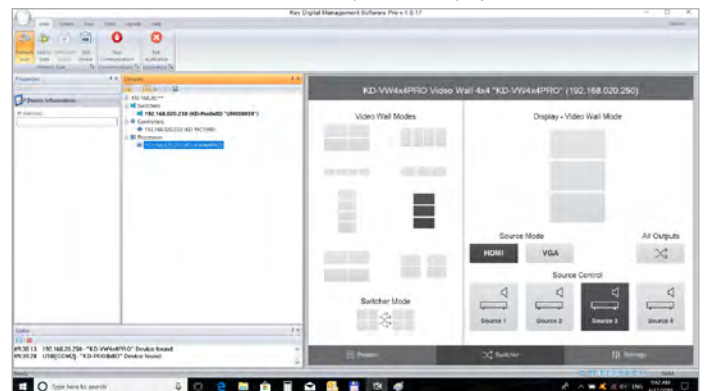

Key Digital® Management Software™ (KDMS™)

Key Digital networked unit management PC software - For End-Users

Key digital
MANAGEMENT SOFTWARE™

KEY FEATURES

- > PC software
- > Signal management tool increases efficiency of AV/IT professionals
- > Supports multiple Key Digital units / systems on same network
- > User-friendly control GUI for compatible Key Digital systems
- > Manage video and audio routing, volume levels, video walls and more:
 - » Enterprise AV™ over IP System
 - » HDMI and HDBaseT matrix switchers
 - » Audio matrix switchers
 - » Presentation switchers
 - » Video wall processors
 - » Multi-viewers

HDBT/HDMI Matrix Switching

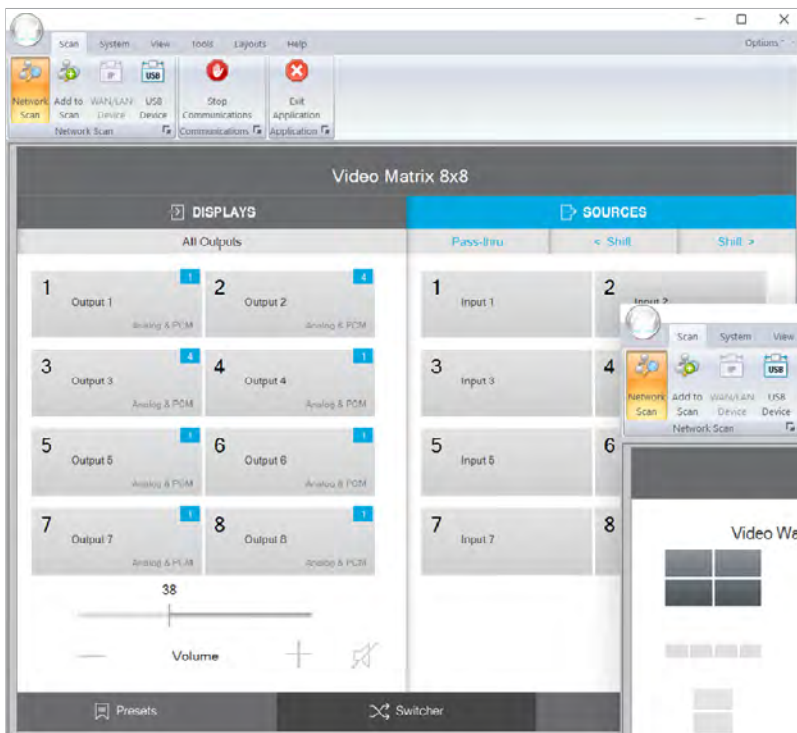

Video Wall Management

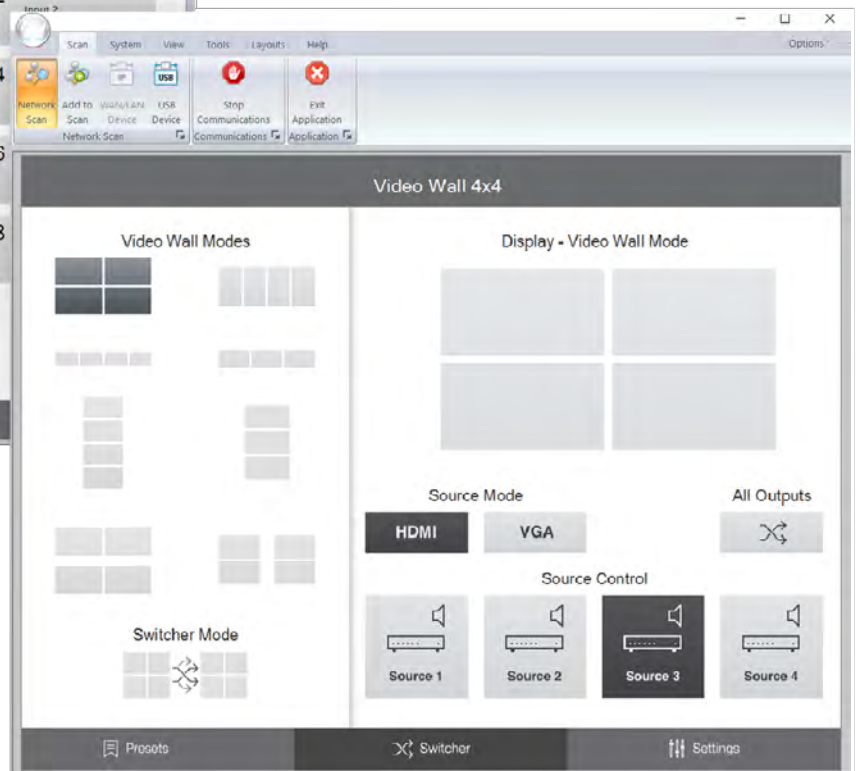

4K Enterprise AV Over IP Solutions

ENTERPRISE AV OVER IP
AUDIO/VIDEO/CONTROL SOLUTIONS

Key Digital's Enterprise AV over IP solutions create expandable HDMI over IP systems that can be scaled to fit any commercial installation.

Key digital PRO
MANAGEMENT SOFTWARE

KEY DIGITAL
APP READY

HDMI
HIGH DEFINITION MULTIMEDIA INTERFACE

KD-IP1022ENC

4K UHD AV over IP Encoder with Independent Video, Audio, KVM/USB Routing. Audio De-Embed with Volume, Delay, and Bass/Mid/Treble Control, 2 port PoE LAN Switch, HDMI Pass-through, 3 port IR, RS-232, Trigger Master Controller / Control Gateway.

» ENCODER

- » **Enterprise AV Over IP:** Utilizes a managed gigabit network switch to enable video distribution, matrix switching, and extension
- » **Video Wall Processing:** Encoder + Decoder systems create video walls with up to 16 vertical and 16 horizontal monitors
- » **Independent Switching:** Video, Audio, and USB switching all independently routable routed for multi-layer systems
- » **Control:** 3 multi-function ports may be used as third-party control interface, Compass Control® Pro master controller, control extension via IP, or callable via KeyCode open API
- » **Key Digital® App Ready:** Network scan & detect populates pre-built GUI including image preview, and finger drag video wall layout control
- » **HDCP 2.2:** Compliancy up to HDCP 2.2 and backward compliant
- » **4K/Ultra HD Resolution:** Support for 4096x2160 or 3840x2160 24/25/30Hz at 4:4:4/8 Bit or 60Hz at 4:2:0/8 Bit (10.2Gbps max bandwidth)
- » **4K Down-scale:** Incoming 4K resolution can be down-converted to 1080p or 720p at each decoder, enabling monitors to display content at optimal resolution at all times
- » **Audio De-Embedding:** At Encoder and Decoder for ease of integration with audio systems
- » **Audio Pre-Amp:** Variable level settings for volume, muting, EQ, balance, and lip-sync delay per Encoder and Decoder
- » **HDMI Pass-Through (ENC):** Enables connection to local monitor or other AV Devices
- » **Local HDMI Input (DEC):** Creates localized input option ideal for presentation spaces
- » **Signal Extension:** Up to 330 ft. / 100 m @ 4K 24/25/30(4:4:4)/60(4:2:0) into network switch or point-to-point
- » **Power over Ethernet:** Does not require power supply when integrated with compatible PoE network switch.
- » **Redundant Power Connection:** Added reliability for non-PoE integration.
- » **Data Stream Bandwidth:** < 900Mbps / **Latency:** <40ms at 4K. Less at lower resolution.
- » **Installation:** Use KD-SMS16 to install up to twelve KD-IP822/ENC/DEC units in rack
- » **Dual LAN:** Built-in switch enables network connectivity and PoE powering of connected devices.



- » **USB 2.0:** Supports synchronous and isochronous connections (web cams not supported)
- » **HDMI® and HDCP Licensing:** Fully licensed and compatible with HDCP 2.2 and HDMI latest technology such as 4K/UHD 4:2:0/8bit at 60 f/s
- » **EDID Control:** Internal library features 15 default EDID configurations and native EDID data from Output/Display devices connected to Decoder
- » **Hot Plug Detection Control:** Enables integrator to choose if active signal voltage is forced to connected input devices
- » **Full Buffer System™:** Manages TMDS re-clocking / signal re-generation, HDCP authentication with source & display, EDID Control handshake, and Hot Plug control
- » **IR Sensor:** Sensor powering via +5V IR In port collects line-of-sight IR from remote(s) without external IR connecting block
- » **Up/Down IR:** Two channels of IR enable control to/from devices connected to Encoder and Decoder units
- » **RS-232:** Bi-Directional control to/from Encoder and Decoder unit on Phoenix connector
- » **RS-232/TCP-IP Control Mode:** Provides control of unit as well as connectivity status
- » **Lossless compressed digital audio:** Support for Dolby® TrueHD, Dolby® Digital Plus, Dolby Atmos®, and DTS-HD Master Audio™
- » **Control System Support:** Controllable by all IR, RS-232 & TCP/IP supported control systems via open API: AMX®, Control4®, Crestron®, KNX®, RTI®, Savant, URC®, Leviton® etc.
- » **Compass Control® Pro Inside:** Built-in 3 port Compass Control® Pro master controller.
 - » KD-ProCL1/2/4/8 Software Activation License sold separately. Required to activate iOS controllers.

Digital Video Matrix Digital Video Distribution System Digital Video Switcher **Video Wall Controller** Digital Video Extender KVM Matrix Master Controller

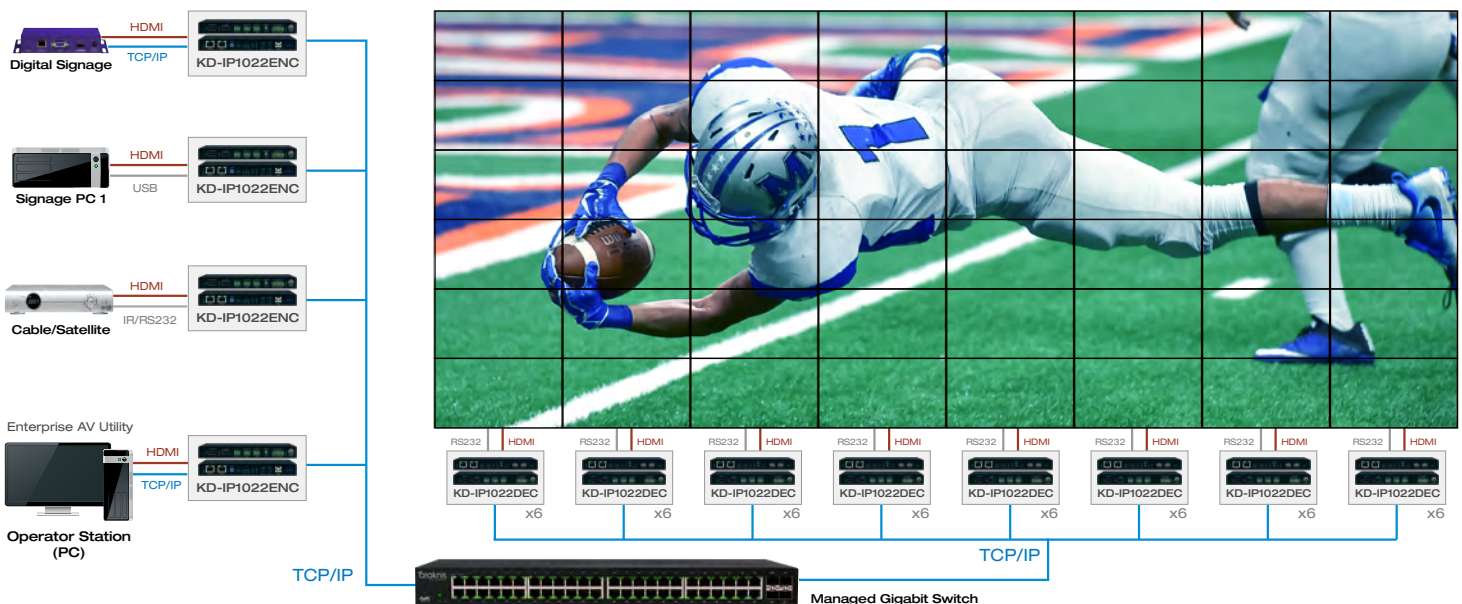

4K Enterprise AV Over IP Solutions

ENTERPRISE AV OVER IP
AUDIO/VIDEO/CONTROL SOLUTIONS

Key Digital's Enterprise AV over IP solutions create expandable HDMI over IP systems that can be scaled to fit any commercial installation.

Key digital PRO
MANAGEMENT SOFTWARE

KEY DIGITAL
APP READY

HDMI
HIGH-DEFINITION MULTIMEDIA INTERFACE

KD-IP1022DEC

4K UHD AV over IP Decoder with Independent Video, Audio, KVM/USB Routing and Video Wall Processing. Audio De-Embed with Volume, Delay, and Bass/Mid/Treble Control, 2 port PoE LAN Switch, Local HDMI In, 3 port IR, RS-232, Trigger Master Controller / Control Gateway.

DECODER >

- ▶ **Enterprise AV Over IP:** Utilizes a managed gigabit network switch to enable video distribution, matrix switching, and extension
- ▶ **Video Wall Processing:** Encoder + Decoder systems create video walls with up to 16 vertical and 16 horizontal monitors
- ▶ **Independent Switching:** Video, Audio, and USB switching all independently routable routed for multi-layer systems
- ▶ **Control:** 3 multi-function ports may be used as third-party control interface, Compass Control® Pro master controller, control extension via IP, or callable via KeyCode open API
- ▶ **Key Digital® App Ready:** Network scan & detect populates pre-built GUI including image preview, and finger drag video wall layout control
- ▶ **HDCP 2.2:** Compliancy up to HDCP 2.2 and backward compliant
- ▶ **4K/Ultra HD Resolution:** Support for 4096x2160 or 3840x2160 24/25/30Hz at 4:4:4/8 Bit or 60Hz at 4:2:0/8 Bit (10.2Gbps max bandwidth)
- ▶ **4K Down-scale:** Incoming 4K resolution can be down-converted to 1080p or 720p at each decoder, enabling monitors to display content at optimal resolution at all times
- ▶ **Audio De-Embedding:** At Encoder and Decoder for ease of integration with audio systems
- ▶ **Audio Pre-Amp:** Variable level settings for volume, muting, EQ, balance, and lip-sync delay per Encoder and Decoder
- ▶ **HDMI Pass-Through (ENC):** Enables connection to local monitor or other AV Devices
- ▶ **Local HDMI Input (DEC):** Creates localized input option ideal for presentation spaces
- ▶ **Signal Extension:** Up to 330 ft. / 100 m @ 4K 24/25/30(4:4:4)/60(4:2:0) into network switch or point-to-point
- ▶ **Power over Ethernet:** Does not require power supply when integrated with compatible PoE network switch.
- ▶ **Redundant Power Connection:** Added reliability for non-PoE integration.
- ▶ **Data Stream Bandwidth:** < 900Mbps / **Latency:** <40ms at 4K. Less at lower resolution.
- ▶ **Installation:** Use KD-SMS16 to install up to twelve KD-IP822/ENC/DEC units in rack
- ▶ **Dual LAN:** Built-in switch enables network connectivity and PoE powering of connected devices.



- ▶ **USB 2.0:** Supports synchronous and isochronous connections (web cams not supported)
- ▶ **HDMI® and HDCP Licensing:** Fully licensed and compatible with HDCP 2.2 and HDMI latest technology such as 4K/UHD 4:2:0/8bit at 60 f/s
- ▶ **EDID Control:** Internal library features 15 default EDID configurations and native EDID data from Output/Display devices connected to Decoder
- ▶ **Hot Plug Detection Control:** Enables integrator to choose if active signal voltage is forced to connected input devices
- ▶ **Full Buffer System™:** Manages TMDS re-clocking / signal re-generation, HDCP authentication with source & display, EDID Control handshake, and Hot Plug control
- ▶ **IR Sensor:** Sensor powering via +5V IR In port collects line-of-sight IR from remote(s) without external IR connecting block
- ▶ **Up/Down IR:** Two channels of IR enable control to/from devices connected to Encoder and Decoder units
- ▶ **RS-232:** Bi-Directional control to/from Encoder and Decoder unit on Phoenix connector
- ▶ **RS-232/TCP-IP Control Mode:** Provides control of unit as well as connectivity status
- ▶ **Lossless compressed digital audio:** Support for Dolby® TrueHD, Dolby® Digital Plus, Dolby Atmos®, and DTS-HD Master Audio™
- ▶ **Control System Support:** Controllable by all IR, RS-232 & TCP/IP supported control systems via open API: AMX®, Control4®, Crestron®, KNX®, RTI®, Savant, URC®, Leviton® etc.
- ▶ **Compass Control® Pro Inside:** Built-in 3 port Compass Control® Pro master controller.
 - » KD-ProCL1/2/4/8 Software Activation License sold separately. Required to activate iOS controllers.

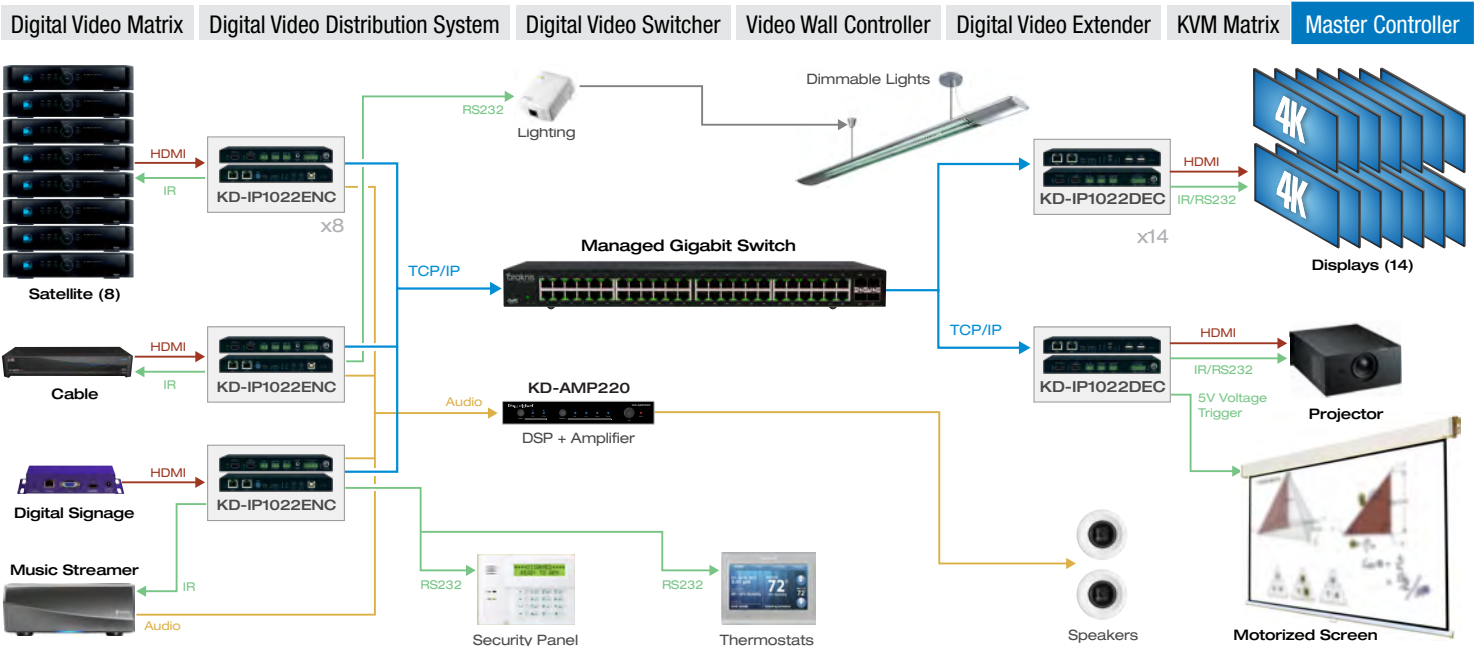

4K Enterprise AV Over IP Solutions

ENTERPRISE AV OVER IP
AUDIO/VIDEO/CONTROL SOLUTIONS

Key Digital's Enterprise AV over IP solutions create expandable HDMI over IP systems that can be scaled to fit any commercial installation.

KEY digital PRO
MANAGEMENT SOFTWARE

KEY DIGITAL
APP READY

KD-IP922ENC

4K UHD AV over IP Encoder, 2 PoE ports LAN Switch, HDMI Pass-through, Audio In, Audio De-Embedding with Lip-Sync & DSP, KVM/USB

- ▶ **Enterprise AV Over IP:** Utilizes a managed gigabit network switch to enable video distribution, matrix switching, and extension. [Visit product page for Usage Modes.](#)
- ▶ **Video Wall Processing:** Encoder + Decoder systems create video walls with up to 10V and 10H monitors
- ▶ **HDCP 2.2:** Compliancy up to HDCP 2.2 and backward compliant
- ▶ **4K/Ultra HD Resolution:** Support for 4096x2160 or 3840x2160 24/25/30Hz at 4:4:4/8 Bit or 60Hz at 4:2:0/8 Bit
- ▶ **Signal Extension:** Up to 330 ft. / 100 m @ 4K 24/25/30(4:4:4)/60(4:2:0) into network switch or point-to-point
- ▶ **Power over Ethernet:** Does not require power supply when integrated with compatible PoE network switch
- ▶ **Dual LAN:** Enable system expansion beyond a 48 port system
- ▶ **Redundant Power Supply:** Added reliability for non-PoE integration
- ▶ **Audio De-Embedding:** Audio from the HDMI input is de-embedded through Analog L/R Balanced/Unbalanced phoenix terminal to enable external audio connectivity with audio distribution systems and amplifiers
- ▶ **Audio DSP:** Volume, muting, 3-band EQ, and lip-sync delay controllable on audio de-embed port
- ▶ **HDMI Pass-Through:** Enables connection to local monitor or additional devices up to 75 ft.
- ▶ **HDMI® and HDCP Licensing:** Fully licensed and compatible with HDCP 2.2 and HDMI latest technology such as 4K/UHD 4:2:0/8bit at 60f/s
- ▶ **Control:** 3 multi-function ports controllable via KeyCode open API, as Compass Control® master controller, or as control extension via IP
- ▶ **USB 2.0:** Supports synchronous and isochronous connections
- ▶ **EDID Control:** Internal library features 15 default EDID configurations and native EDID data from Output/Display devices connected to Decoder
- ▶ **Hot Plug Detection Control:** Enables integrator to choose if active signal voltage is forced to connected input devices

» ENCODER



- ▶ **Full Buffer System™:** Manages TMDS re-clocking / signal re-generation, HDCP authentication with source & display, EDID Control handshake, and Hot Plug control
- ▶ **IR Sensor:** Sensor powering via +5V IR In port collects line-of-sight IR from remote(s) without external IR connecting block
- ▶ **Up/Down IR:** Two channels of IR enable control to/from devices connected to Encoder and Decoder units
- ▶ **RS-232:** Bi-Directional control to/from Encoder and Decoder unit on Phoenix connector
- ▶ **RS-232/TCP-IP Control Mode:** Provides control of unit as well as connectivity status
- ▶ **Lossless compressed digital audio:** Support for Dolby® TrueHD, Dolby® Digital Plus, Dolby Atmos®, and DTS-HD Master Audio™
- ▶ **Required Network Cabling:** CAT6 UTP/STP, CAT6A, CAT7. Shielded cabling requires shielded RJ45 connectors on both ends.
- ▶ **Control System Support:** Controllable by all IR, RS-232 & TCP/IP supported control systems via open API: AMX®, Control4®, Crestron®, KNX®, RTI®, Savant, URC®, Leviton® etc.
- ▶ **Compass Control® Pro Inside:** Built-in 3 port Compass Control® Pro master controller.
 - » KD-ProCL1/2/4/8 Software Activation License sold separately. Required to activate iOS controllers.
- ▶ **Key Digital® App Ready:** Can be controlled over TCP/IP via Key Digital® iOS App
- ▶ **Data Stream Bandwidth:** < 900Mbps / Latency: < 40ms at 4K

SPECIFICATIONS

- » Regulation: CE, RoHS, WEEE, EAC
- » Enclosure: Black Metal
- » Product (Each): 7.5" x 5.59" x 0.85", Weight: 0.7 lbs

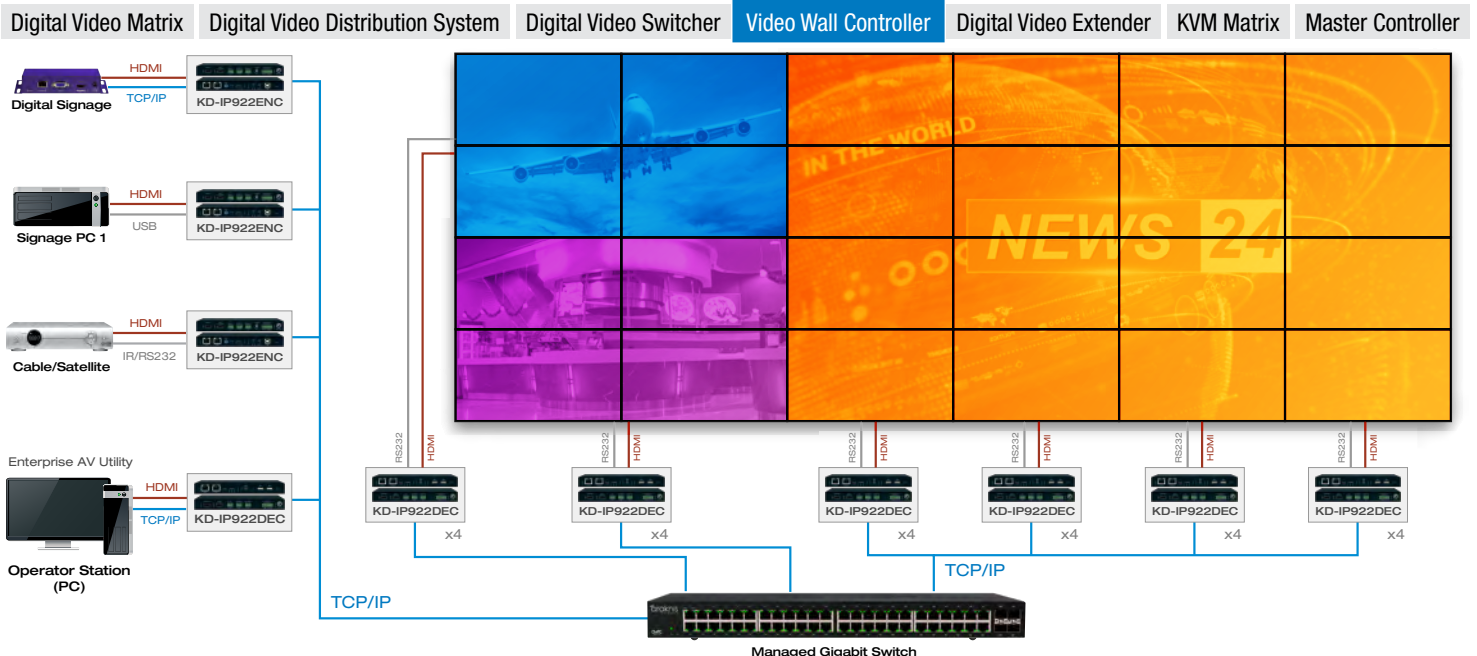

4K Enterprise AV Over IP Solutions

ENTERPRISE AV™ OVER IP
AUDIO/VIDEO/CONTROL SOLUTIONS

Key Digital's Enterprise AV over IP solutions create expandable HDMI over IP systems that can be scaled to fit any commercial installation.

Key digital PRO
MANAGEMENT SOFTWARE

KEY DIGITAL
APP READY

KD-IP822ENC

4K UHD AV over IP Encoder, PoE, HDMI Pass-Thru, 2x IR/RS-232 ports

KEY FEATURES

- ▶ **Enterprise AV™ Over IP:** Utilizes a managed gigabit network switch to enable video distribution, matrix switching, and extension
- ▶ **Inter-System Compatibility:** Fully compatible with KD-IP922ENC and DEC systems
- ▶ **Video Wall Processing:** Encoder + Decoder systems create video walls with up to 4 total displays. Use KD-IP922DEC for larger video wall configurations
- ▶ **Control:** 2 multi-function ports may be used as third-party control interface, Compass Control® Pro master controller, control extension via IP, or callable via KeyCode open API
- ▶ **Key Digital® App Ready:** Network scan & detect populates pre-built GUI including image preview
- ▶ **HDCP 2.2:** Compliancy up to HDCP 2.2 and backward compliant
- ▶ **4K/Ultra HD Resolution:** Support for 4096x2160 or 3840x2160 24/25/30Hz at 4:4:4/8 Bit or 60Hz at 4:2:0/8 Bit
- ▶ **4K Down-scale:** Incoming 4K resolution can be down-converted to 1080p or 720p at each decoder, enabling monitors to display content at optimal resolution at all times
- ▶ **Signal Extension:** Up to 330 ft. / 100 m @ 4K 24/25/30(4:4:4)/60(4:2:0) into network switch or or point-to-point
- ▶ **Power over Ethernet:** Does not require power supply when integrated with compatible PoE network switch
- ▶ **Redundant Power Connection:** Added reliability for non-PoE integration. Power supply sold separately
- ▶ **Data Stream Bandwidth:** < 900Mbps / Latency: <40ms at 4K
- ▶ **Installation:** Use KD-SMS16 to cleanly install up to twelve KD-IP822ENC/DEC units in rack
- ▶ **HDMI® and HDCP Licensing:** Fully licensed and compatible with HDCP 2.2 and HDMI latest technology such as 4K/UHD 4:2:0/8bit at 60 f/s
- ▶ **EDID Control:** Internal library features 15 default EDID configurations and native EDID data from Output/Display devices connected to Decoder



- ▶ **Hot Plug Detection Control:** Enables integrator to choose if active signal voltage is forced to connected input devices
- ▶ **Full Buffer System™:** Manages TMDS re-clocking / signal re-generation, HDCP authentication with source & display, EDID Control handshake, and Hot Plug control
- ▶ **IR Sensor:** Sensor powering via +5V IR In port collects line-of-sight IR from remote(s) without external IR connecting block
- ▶ **Up/Down IR:** Two channels of IR enable control to/from devices connected to Encoder and Decoder units
- ▶ **RS-232:** Bi-Directional control to/from Encoder and Decoder unit on Phoenix connector
- ▶ **RS-232/TCP-IP Control Mode:** Provides control of unit as well as connectivity status
- ▶ **Lossless compressed digital audio:** Support for Dolby® TrueHD, Dolby® Digital Plus, Dolby Atmos®, and DTS-HD Master Audio™
- ▶ **Control System Support:** Controllable by all IR, RS-232 & TCP/IP supported control systems via open API: AMX®, Control4®, Crestron®, KNX®, RTI®, Savant, URC®, Leviton® etc.
- ▶ **Compass Control® Pro Inside:** Built-in 3 port Compass Control® Pro master controller.
 - ▶ KD-ProCL1/2/4/8 Software Activation License sold separately. Required to activate iOS controllers.

SPECIFICATIONS

- ▶ Regulation: CE, RoHS, WEEE, EAC
- ▶ Enclosure: Black Metal
- ▶ Product (Each): 7.5" x 5.59" x 0.85", Weight: 0.7 lbs

Digital Video Matrix

Digital Video Distribution System

Digital Video Switcher

Video Wall Controller

Digital Video Extender

Master Controller

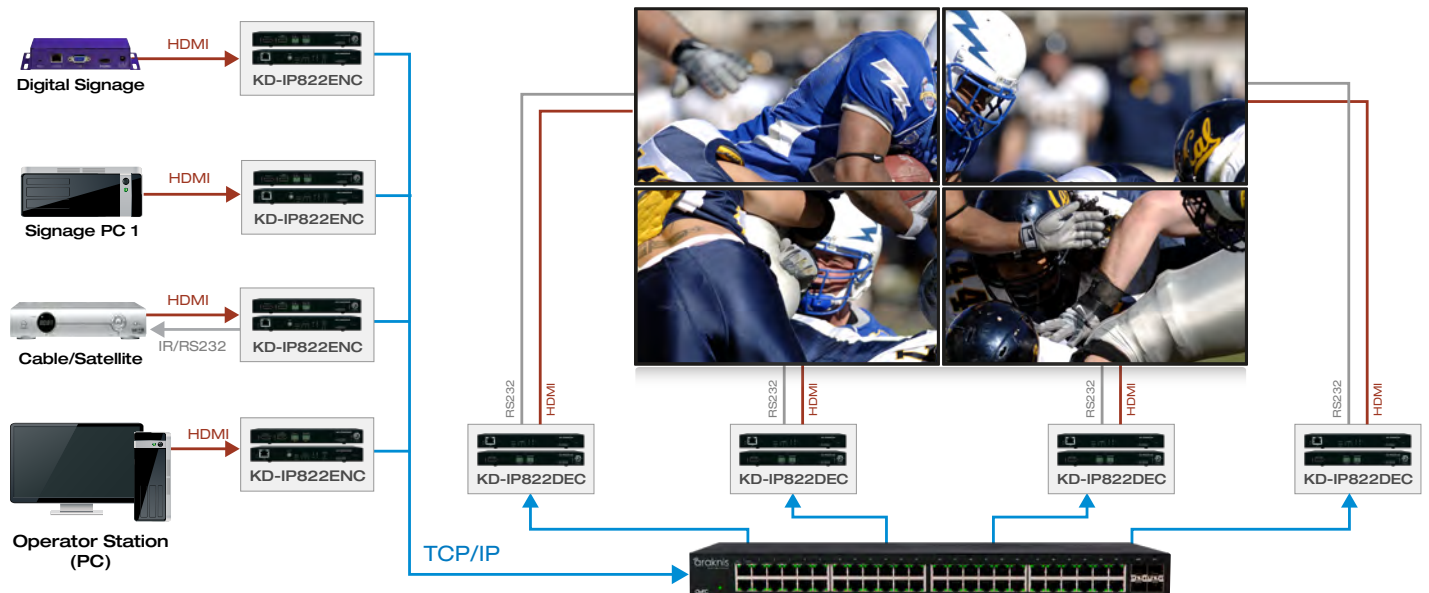

4K Enterprise AV Over IP Solutions

ENTERPRISE AV™ OVER IP
AUDIO/VIDEO/CONTROL SOLUTIONS

Key Digital's Enterprise AV over IP solutions create expandable HDMI over IP systems that can be scaled to fit any commercial installation.

Key digital PRO
MANAGEMENT SOFTWARE

KEY DIGITAL
APP READY

KD-IP822DEC

4K UHD AV over IP Decoder, PoE, 2x IR/RS-232 control ports

KEY FEATURES

- » **Enterprise AV™ Over IP:** Utilizes a managed gigabit network switch to enable video distribution, matrix switching, and extension
- » **Inter-System Compatibility:** Fully compatible with KD-IP922ENC and DEC systems
- » **Video Wall Processing:** Encoder + Decoder systems create video walls with up to 4 total displays. Use KD-IP922DEC for larger video wall configurations
- » **Control:** 2 multi-function ports may be used as third-party control interface, Compass Control® Pro master controller, control extension via IP, or callable via KeyCode open API
- » **Key Digital® App Ready:** Network scan & detect populates pre-built GUI including image preview
- » **HDCP 2.2:** Compliancy up to HDCP 2.2 and backward compliant
- » **4K/Ultra HD Resolution:** Support for 4096x2160 or 3840x2160 24/25/30Hz at 4:4:4/8 Bit or 60Hz at 4:2:0/8 Bit
- » **4K Down-scale:** Incoming 4K resolution can be down-converted to 1080p or 720p at each decoder, enabling monitors to display content at optimal resolution at all times
- » **Signal Extension:** Up to 330 ft. / 100 m @ 4K 24/25/30(4:4:4)/60(4:2:0) into network switch or or point-to-point
- » **Power over Ethernet:** Does not require power supply when integrated with compatible PoE network switch
- » **Redundant Power Connection:** Added reliability for non-PoE integration. Power supply sold separately
- » **Data Stream Bandwidth:** < 900Mbps / Latency: <40ms at 4K
- » **Installation:** Use KD-SMS16 to cleanly install up to twelve KD-IP822ENC/DEC units in rack
- » **HDMI® and HDCP Licensing:** Fully licensed and compatible with HDCP 2.2 and HDMI latest technology such as 4K/UHD 4:2:0/8bit at 60 f/s
- » **EDID Control:** Internal library features 15 default EDID configurations and native EDID data from Output/Display devices connected to Decoder



- » **Hot Plug Detection Control:** Enables integrator to choose if active signal voltage is forced to connected input devices
- » **Full Buffer System™:** Manages TMDS re-clocking / signal re-generation, HDCP authentication with source & display, EDID Control handshake, and Hot Plug control
- » **IR Sensor:** Sensor powering via +5V IR In port collects line-of-sight IR from remote(s) without external IR connecting block
- » **Up/Down IR:** Two channels of IR enable control to/from devices connected to Encoder and Decoder units
- » **RS-232:** Bi-Directional control to/from Encoder and Decoder unit on Phoenix connector
- » **RS-232/TCP-IP Control Mode:** Provides control of unit as well as connectivity status
- » **Lossless compressed digital audio:** Support for Dolby® TrueHD, Dolby® Digital Plus, Dolby Atmos®, and DTS-HD Master Audio™
- » **Control System Support:** Controllable by all IR, RS-232 & TCP/IP supported control systems via open API: AMX®, Control4®, Crestron®, KNX®, RTI®, Savant, URC®, Leviton® etc.
- » **Compass Control® Pro Inside:** Built-in 3 port Compass Control® Pro master controller.
 - » KD-ProCL1/2/4/8 Software Activation License sold separately. Required to activate iOS controllers.

SPECIFICATIONS

- » Regulation: CE, RoHS, WEEE, EAC
- » Enclosure: Black Metal
- » Product (Each): 7.5" x 5.59" x 0.85", Weight: 0.7 lbs

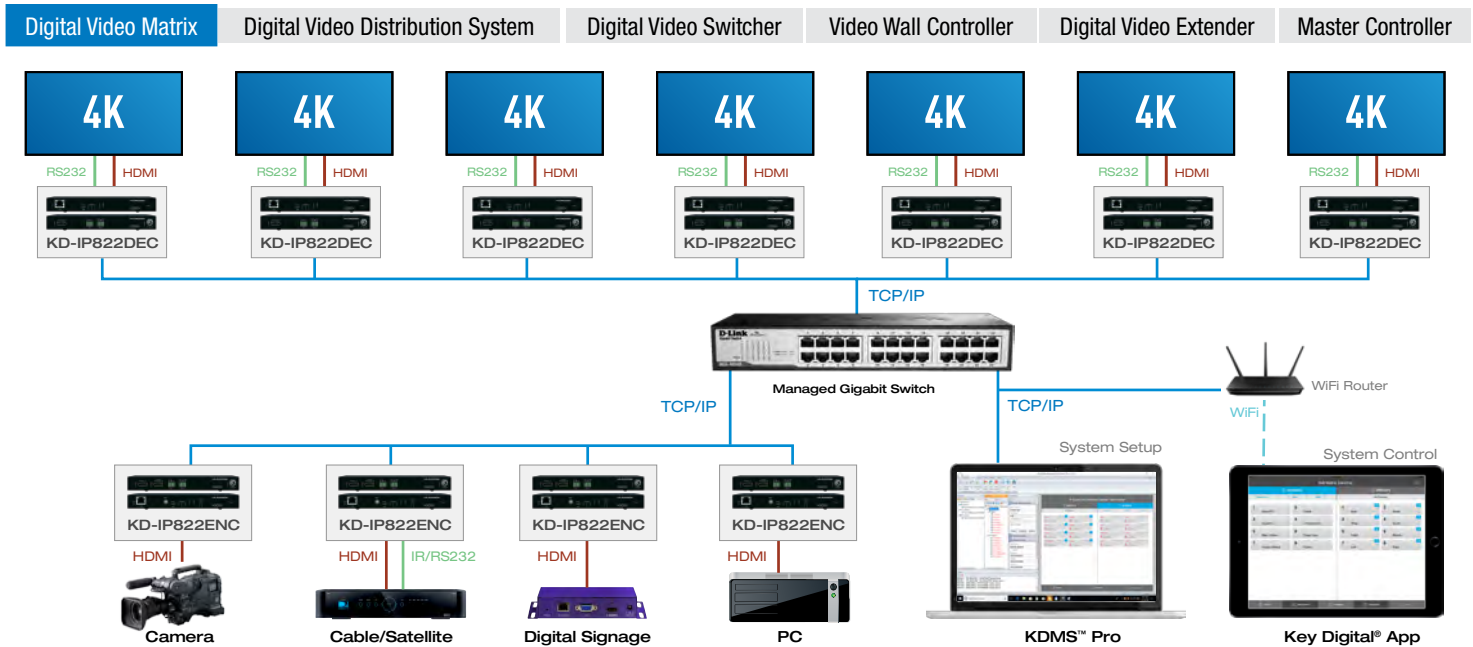

1080p HDMI Over IP Solutions

ENTERPRISE AV™ OVER IP
AUDIO/VIDEO/CONTROL SOLUTIONS

Key Digital's Enterprise A™ over IP solutions create expandable HDMI over IP systems that can be scaled to fit any commercial installation.

Key digital PRO
MANAGEMENT SOFTWARE

KEY DIGITAL
APP READY

KD-IP1080Tx

HDMI over IP with POE (Tx) Transmitter with Redundant Power Connection, HDMI Pass-through



KEY FEATURES

- › **Connectivity:** Can be connected through a network IP switch or point-to-point
- › **H.264 Compression:** Ideal standard for large video distribution applications
- › **Low-bandwidth System:** Supports managed 100BaseT or Gigabit network switches
- › **Power Over Ethernet:** Carry power to Tx and Rx units with a Power Over Ethernet enabled Smart Managed Switch
- › **Custom System:** Add Tx and Rx extenders to an existing system to expand it up to 1024 Tx units and unlimited amount of Rx units
- › **Alternative Extension Methods:** Enabled by low-bandwidth data streaming technology
 - › Wifi Extender: **Up to 100 ft.**
 - › IP over Coaxial: **Up to 1000 ft.**
- › **Web Control Interface:** Reduces installation time and provides basic video setup.
- › **Full Buffer System™:** Manages TMDS re-clocking / signal re-generation, HDCP authentication to source & display, and EDID Control handshake
- › **Resolution Support:** Supports up to 1080p@60 (2.25Gbps) and compatible with DVI1.0/HDMI/HDCP1.x
- › **HDMI Pass-through:** Tx unit support HDMI Pass-through to receive video or extract audio on the transmit side
- › **Redundant Power Supply:** Added reliability and for non-PoE integration
- › **Audio Format:** Supports 2ch PCM at 44.1/48kHz

KD-IP1080Rx

HDMI over IP with POE (Rx) Receiver with Redundant Power Connection



- › **AV Bitrate:** Supports Stream Bitrate up to 15Mbps.
- › **EDID:** EDID libraries readily available to provide the best setup per source
- › **Deep Color Support:** Up to 12 bits/color
- › **TMDS re-clocking:** Support for long HDMI runs using Key Digital® HDMI cables
- › **Licensing:** Fully licensed and compatible with all HDMI and HDCP technologies
- › **Control:** Key Digital App ready. Compass Control® Pro ready. Fully controllable by RS-232 supported control systems via open API.
- › **Key Digital® App Ready:** Can be controlled over TCP/IP via Key Digital® iOS App
- › **Source/Display Control:** Integrate with KD-CX800 to add 3 IR, RS-232 or Trigger ports

SPECIFICATIONS

- › Tx Input: 1 HDMI Connector, Type A, 19 Pin Female
- › Tx Output: 1 HDMI Connector, Type A, 19 Pin Female; 1 CAT5e/6 on RJ45
- › Rx Input: 1 CAT5e/6 on RJ45
- › Tx Output: 1 HDMI Connector, Type A, 19 Pin Female
- › POE Power Consumption: ≤ 6 watts per unit
- › Regulation: CE, RoHS, WEEE, EAC
- › Enclosure: Black Metal
- › Rack Mount: 3U with KD-RK120PLT bracket (sold separately)
- › Product (Each): 4.74" x 3.11" x 1.16", Weight: 0.6 lbs
- › Packaging: 6.2" x 4.2" x 3.7"; Weight 2 lbs

HDMI OVER IP SYSTEM WITH CONTROL EXTENSION

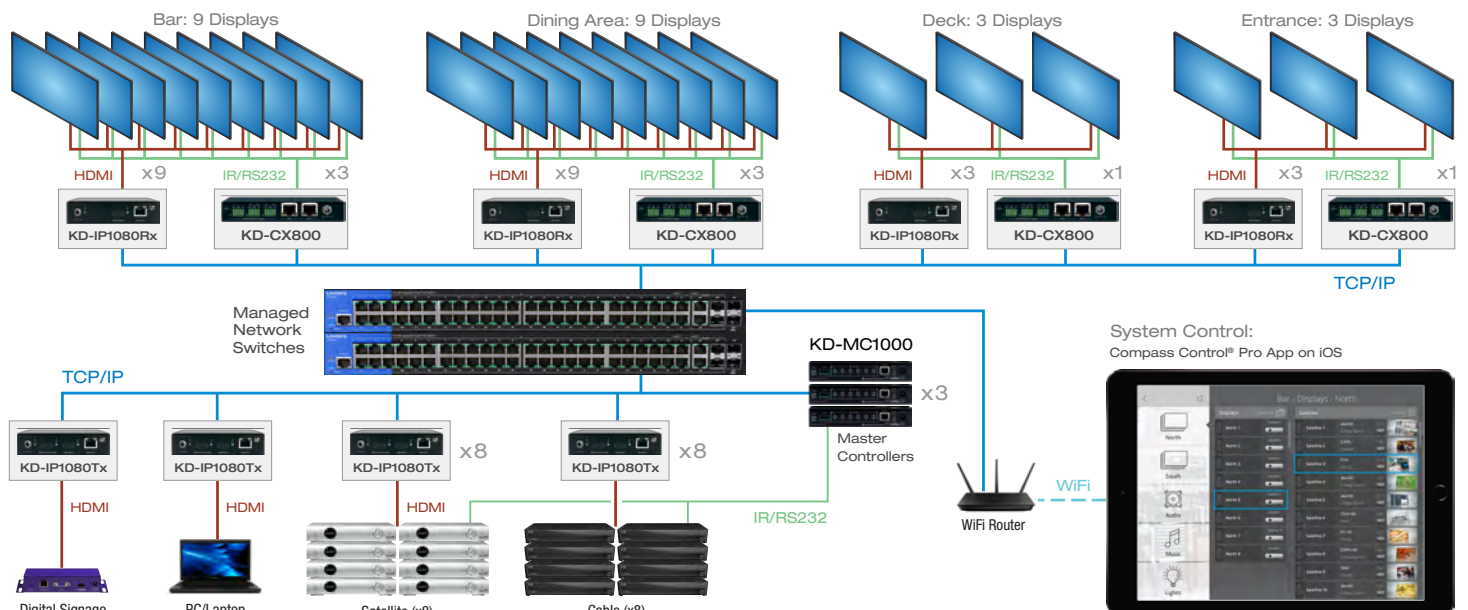



Key Digital Presentation Solutions are a family of products integrating a Soft-Codec Enabling System with HDBT/HDMI/Audio/Control hardware designed for professional audio video installations in conference rooms, board rooms, classrooms, lecture halls, auditoriums, and more.



KD-UPS52U

4K/18G USB/Universal Presentation Switcher with 5 Inputs (HDBT, 2x HDMI, DP, USB-C), 2 Mirrored Outputs (HDBT, HDMI), LAN, ARC, Audio De-Embed, IR, RS-232, IP Control, CEC Manager™. Includes Rx.

KEY FEATURES

- ▶ **Presentation Switcher Kit:** Includes KD-UPS52U and KD-X100MRx. Add KD-X4x1WUTx wall plate HDBaseT Tx for plug-in on walls, floor and table boxes
- ▶ **Presentation Switching:** 1 HDBaseT, 2 HDMI, 1 Display Port, 1 USB-C source selection by push button, IP, RS-232, IR, auto switching, or trigger control.
- ▶ **Soft-Codec Enabling System:** USB Host + Device ports on KD-UPS52U, KD-X4x1WUTx wall plate transmit (sold separately) and KD-100MRx (included) create connectivity hub for professional USB cameras and microphones, audio DSP, keyboard, mouse, or touchscreen display with connected computer
- ▶ **PTZ USB Camera Integration:** Integrates natively with KD-CAMUSB for full PTZ control via KD-App and more
- ▶ **Ultra HD/4K:** Supports up to 4096x2160 or 3840x2160 24/25/30/60hz at 4:4:4 (signals up to 18Gbps bandwidth)
- ▶ **Auto-Sensing:** Automatic selection of newly detected source and switching from newly disconnected source when enabled
- ▶ **CEC Manager™:** Power, volume, and muting controls of the connected display/projector without any additional control wiring. Selection of desired CEC command recipient.
- ▶ **Audio De-embedding:** Audio of the selected source is de-embedded at the unit's analog L/R balanced/unbalanced and PCM digital audio connectors
- ▶ **KD-AMP220 Control Mode:** Command forward to KD-AMP220 for an all-in-one user-friendly control UI of video switching, audio and speech enforcement
- ▶ **HDCP Licensing:** Fully licensed and compatible with HDCP 2.2
- ▶ **HDR10 and Dolby Vision:** More life-like images through a greater range of luminance levels
- ▶ **Power Over HDBaseT:** Rx unit (included) and wall plate Tx unit (sold separately) powered by KD-UPS52U
- ▶ **Installation:** Half-rack width with rack mounting ears included.
- ▶ **Signal Extension:** For resolution and cable quality
 - » 4K/UHD (18G): Up to 100m / 328ft
 - » 1080p: Up to 150m / 492ft
- ▶ **Deep Color Support:** Up to UHD/4K 30Hz 4:4:4/12 bits or 60Hz 4:4:4/8 bit



- ▶ **Full Buffer System™:** Manages TMDS re-clocking / signal re-generation, HDCP authentication to source & display, EDID Control handshake, and Hot Plug Detection Voltage
- ▶ **EDID Management:** Internal library with 15 internal EDID handshakes including 4K with HDR in addition to native EDID data copied from the Rx display/device
- ▶ **RS-232:** Bi-Directional control to/from Tx and Rx/Presentation Switch unit
- ▶ **Unit Control Mode:** Provides TCP/IP and RS-232 control and status of/from Tx unit
- ▶ **Lossless compressed digital audio:** Support for Dolby® TrueHD, Dolby® Digital Plus, Dolby Atmos®, and DTS-HD Master Audio™
- ▶ **Control System Support:** Fully controllable by all TCP/IP and RS-232 supported control systems via open API: Compass Control® Pro, AMX®, Crestron®, KNX®, RTI®, Savant, URC®, Leviton® etc.
- ▶ **KD-App Ready:** Network scan & detect populates pre-built GUI including connected display/projector controls via CEC Manager™

SPECIFICATIONS

- » Regulation: CE, RoHS, WEEE, EAC
- » Enclosure: Black Metal

SYSTEM DESIGN EXAMPLE

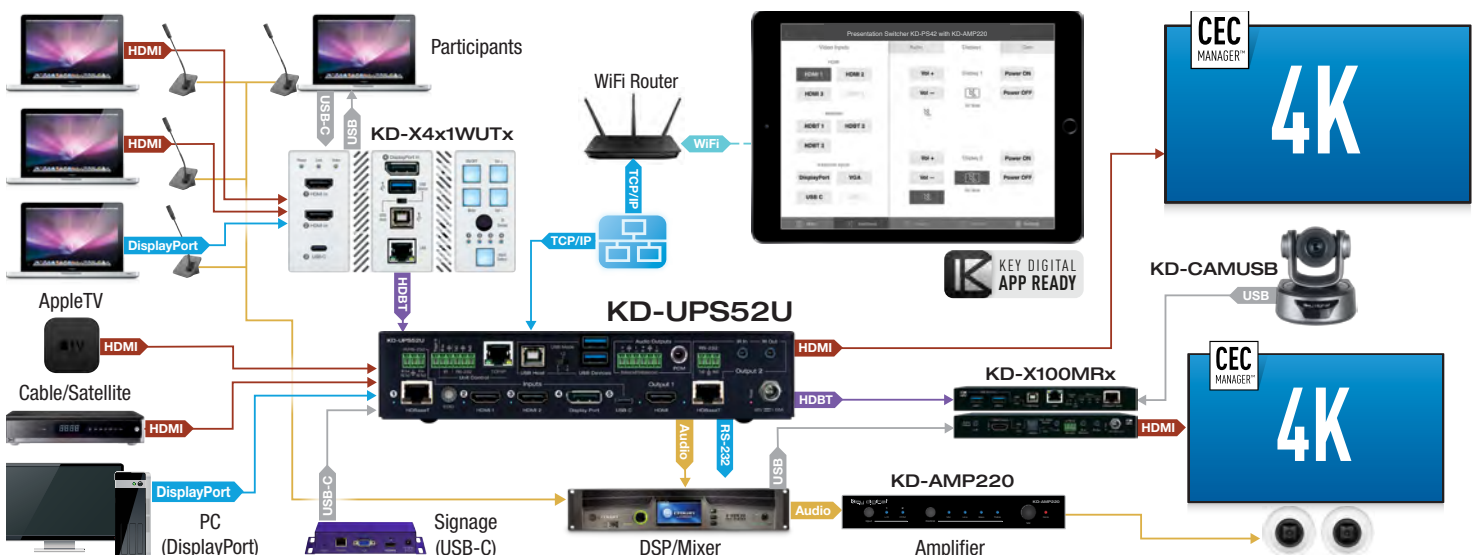



Key Digital Presentation Solutions are a family of products integrating a Soft-Codec Enabling System with HDBT/HDMI/Audio/Control hardware designed for professional audio video installations in conference rooms, board rooms, classrooms, lecture halls, auditoriums, and more.



KD-PS42

4K/18G Presentation Switcher with 4 Inputs (HDBT, 3x HDMI), 2 Mirrored Outputs (HDBT, HDMI), Audio De-Embed, IR, RS-232, IP, CEC Manager™. Includes Rx.

KEY FEATURES

- › **Presentation Switcher Kit:** Includes KD-PS42 and KD-X40MRx. Add KD-X2x1WDTx wall plate HDBaseT transmitter for plug-in on walls, floor and table boxes
- › **Presentation Switching:** 3 HDMI, 1 HDBaseT source selection by push button, IP, RS-232, IR, auto switching, or trigger control.
- › **Ultra HD/4K:** Supports up to 4096x2160 or 3840x2160 24/25/30/60hz at 4:4:4 (signals up to 18Gbps bandwidth)
- › **Auto-Sensing:** Automatic selection of newly detected source and switching from newly disconnected source when enabled
- › **CEC Manager™:** Power, volume, and muting controls of the connected display/projector without any additional control wiring. Selection of desired CEC command recipient.
- › **Audio De-embedding:** Audio of the selected source is de-embedded at the unit's analog L/R balanced/unbalanced and PCM digital audio connectors.
- › **KD-AMP220 Control Mode:** Command forward to KD-Amp220 for an all-in-one user-friendly control UI of video switching, audio and speech enforcement
- › **HDCP Licensing:** Fully licensed and compatible with HDCP 2.2
- › **HDR10 and Dolby Vision:** More life-like images through a greater range of luminance levels
- › **Power Over HDBaseT:** Rx unit (included) and wall plate Tx unit (sold separately) powered by KD-PS42
- › **Installation:** Half-rack width with rack mounting ears included.
- › **Signal Extension:** For resolution and cable quality
 - › 4K/UHD (18G): Up to 40m / 131ft
 - › 1080p: Up to 70m / 230ft
- › **Deep Color Support:** Up to UHD/4K 30Hz 4:4:4/12 bits or 60Hz 4:4:4/8 bit
- › **Full Buffer System™:** Manages TMDS re-clocking / signal re-generation, HDCP authentication to source & display, EDID Control handshake, and Hot Plug Detection Voltage
- › **EDID Management:** Internal library with 15 internal EDID handshakes including 4K with HDR in addition to native EDID data copied from the Rx display/device



- › **RS-232:** Bi-Directional control to/from Tx and Rx/Presentation Switcher unit
- › **Unit Control Mode:** Provides TCP/IP and RS-232 control and status of/from Tx unit
- › **EDID Management:** Internal library with 15 internal EDID handshakes including 4K with HDR in addition to native EDID data copied from the output/display 1
- › **Lossless compressed digital audio:** Support for Dolby® TrueHD, Dolby® Digital Plus, Dolby Atmos®, and DTS-HD Master Audio™
- › **Control System Support:** Fully controllable by all TCP/IP and RS-232 supported control systems via open API: Compass Control® Pro, AMX®, Crestron®, KNX®, RTI®, Savant, URC®, Leviton® etc.
- › **KD-App Ready:** Network scan & detect populates pre-built GUI including connected display/projector controls via CEC Manager™

SPECIFICATIONS

- › Regulation: CE, RoHS, WEEE, EAC
- › Enclosure: Black Metal

SYSTEM DESIGN EXAMPLE

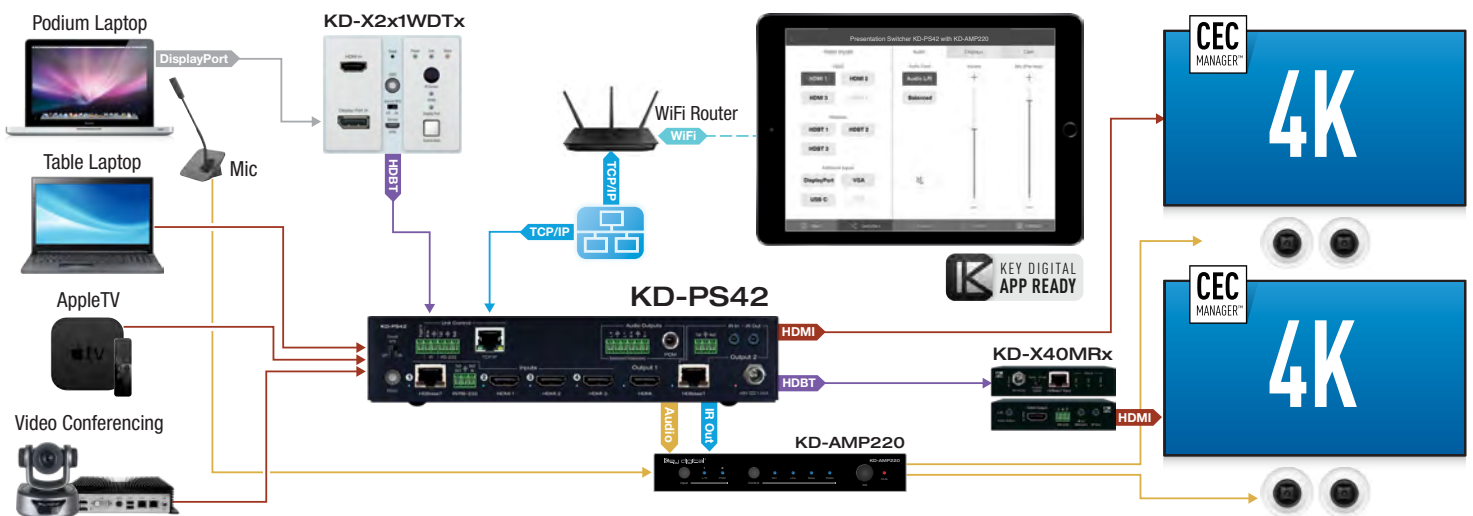



Key Digital Presentation Solutions are a family of products integrating a Soft-Codec Enabling System with HDBT/HDMI/Audio/Control hardware designed for professional audio video installations in conference rooms, board rooms, classrooms, lecture halls, auditoriums, and more.



KD-X4x1WUTx

4x1 4K/18G 100m HDBT PoH Wall Plate Switcher with 2x HDMI, DP, USB-C, USB, LAN, ARC, Audio De-Embed, IR, RS-232, IP Control, CEC Manager™. Transmitter Only.

KEY FEATURES

- ▶ **Presentation Switching:** 2 HDMI, 1 Display Port, and 1 USB-C source selection by push button or IP control.
- ▶ **Rx Options:** Native integration with KD-X100MRx black box HDBaseT Rx, KD-UPS52U and KD-UPS72U Presentation Switchers. Other Rx options available.
- ▶ **Soft-Codec Enabling System:** USB Host + Device ports on wall plate and chosen Rx / Presentation Switch create connectivity hub for professional USB cameras and microphones, audio DSP, keyboard, mouse, or touchscreen display with connected computer
- ▶ **PTZ USB Camera Integration:** Marries natively with KD-CAMUSB for full PTZ control via KD-App and more
- ▶ **Ultra HD/4K:** Supports up to 4096x2160 or 3840x2160 24/25/30/60hz at 4:4:4 (signals up to 18Gbps bandwidth)
- ▶ **Auto-Sensing:** Automatic selection of newly detected source and switching from newly disconnected source when enabled
- ▶ **CEC Manager™:** Power, volume, and muting controls of the connected displays/projectors without any additional control wiring.
- ▶ **Audio De-embedding:** Audio of the selected source is de-embedded at the unit's analog L/R balanced/unbalanced connector
- ▶ **HDCP Licensing:** Fully licensed and compatible with HDCP 2.2
- ▶ **HDR10 and Dolby Vision:** More life-like images through a greater range of luminance levels
- ▶ **Power Over HDBaseT:** Wall-plate unit powered by Rx/Presentation Switch unit
- ▶ **Installation:** Tx unit designed for installation in standard US three-gang box
- ▶ **Signal Extension:** For resolution and cable quality
 - » 4K/UHD (18G): Up to 100m / 328ft
 - » 1080p: Up to 150m / 492ft
- ▶ **Deep Color Support:** Up to UHD/4K 30Hz 4:4:4/12 bits or 60Hz 4:4:4/8 bit
- ▶ **Full Buffer System™:** Manages TMDS re-clocking / signal re-generation, HDCP authentication to source & display, EDID Control handshake, and Hot Plug Detection Voltage



- ▶ **EDID Management:** Internal library with 15 internal EDID handshakes including 4K with HDR in addition to native EDID data copied from the Rx display/device
- ▶ **IR Sensor:** Wall-plate collects line-of-sight IR from remote(s) without external IR wiring
- ▶ **RS-232:** Bi-Directional control to/from Tx and Rx/Presentation Switch unit
- ▶ **Unit Control Mode:** Provides TCP/IP and RS-232 control and status of/from Tx unit
- ▶ **Lossless compressed digital audio:** Support for Dolby® TrueHD, Dolby® Digital Plus, Dolby Atmos®, and DTS-HD Master Audio™
- ▶ **Control System Support:** Fully controllable by all TCP/IP and RS-232 supported control systems via open API: Compass Control® Pro, AMX®, Crestron®, KNX®, RTI®, Savant, URC®, Leviton® etc.
- ▶ **KD-App Ready:** Network scan & detect populates pre-built GUI including connected display/projector controls via CEC Manager™

SPECIFICATIONS

- » Regulation: CE, RoHS, WEEE, EAC
- » Wallplate: Standard 3-gang Wallplate
- » Enclosure: Faceplate - Silver Brushed Metal, Body - Texturized Silver Metal

SYSTEM DESIGN EXAMPLE

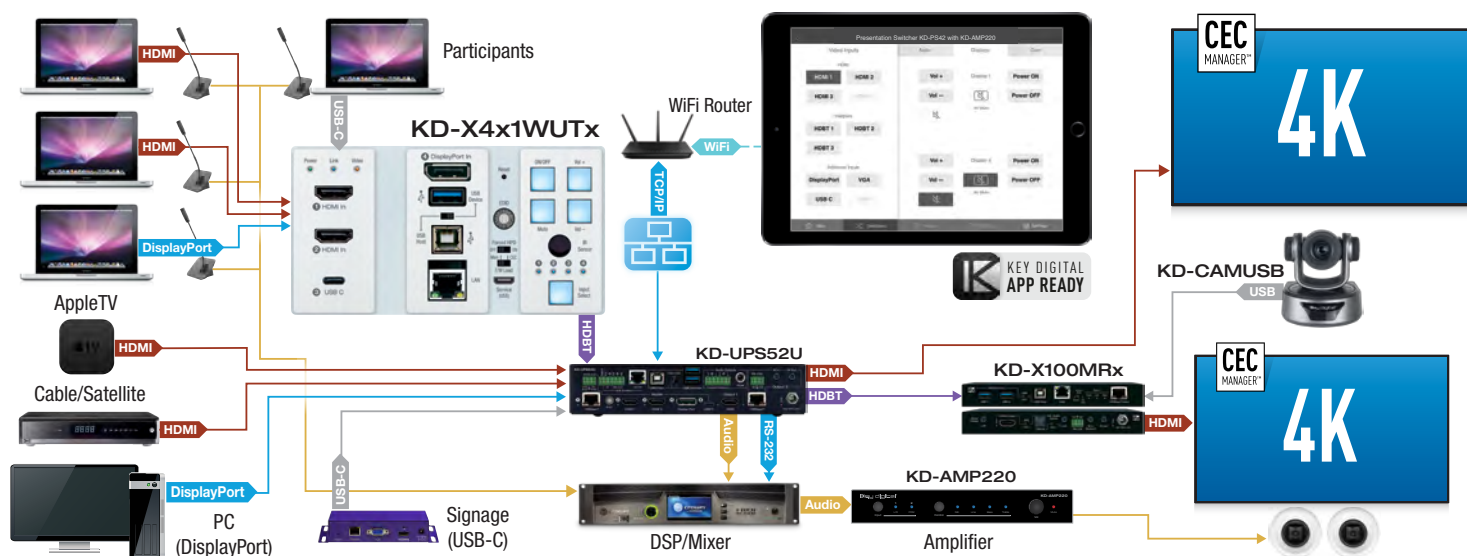



Key Digital Presentation Solutions are a family of products integrating a Soft-Codec Enabling System with HDBT/HDMI/Audio/Control hardware designed for professional audio video installations in conference rooms, board rooms, classrooms, lecture halls, auditoriums, and more.



KD-X2x1WDTx

2x1 4K/18G 40m HDBT PoH Wall Plate Switcher with HDMI & DisplayPort, IR, RS-232. Transmitter Only.

KEY FEATURES

- ▶ **Presentation Switching:** 1 HDMI and 1 Display Port source selected by push button
- ▶ **Rx Options:** Native integration with KD-X40MRx black box HDBaseT Rx and KD-PS42 Presentation Switcher. Other Rx options available.
- ▶ **Ultra HD/4K:** Supports up to 4096x2160 or 3840x2160 24/25/30/60hz at 4:4:4 (signals up to 18Gbps bandwidth)
- ▶ **Auto-Sensing:** Automatic selection of newly detected source and switching from newly disconnected source when enabled
- ▶ **HDCP Licensing:** Fully licensed and compatible with HDCP 2.2
- ▶ **HDR10 and Dolby Vision:** More life-like images through a greater range of luminance levels
- ▶ **Power Over HDBaseT:** Wall-plate unit powered by Rx/Presentation Switch unit
- ▶ **Installation:** Tx unit designed for installation in standard US dual-gang box. Silver decora plate included.
- ▶ **Signal Extension:** For resolution and cable quality
 - » 4K/UHD (18G): Up to 40m / 131ft
 - » 1080p: Up to 70m / 230ft
- ▶ **Deep Color Support:** Up to UHD/4K 30Hz 4:4:4/12 bits or 60Hz 4:4:4/8 bit
- ▶ **Full Buffer System™:** Manages TMDS re-clocking / signal re-generation, HDCP authentication to source & display, EDID Control handshake, and Hot Plug Detection Voltage
- ▶ **EDID Management:** Internal library with 15 internal EDID handshakes including 4K with HDR in addition to native EDID data copied from the Rx display/device
- ▶ **IR Sensor:** Wall-plate collects line-of-sight IR from remote(s) without external IR wiring
- ▶ **RS-232:** Bi-Directional control to/from Tx and Rx/Presentation Switch unit
- ▶ **Unit Control:** via USB for initial installation steps
- ▶ **Lossless Compressed Digital Audio:** Dolby® TrueHD, Dolby® Digital Plus, DTS-HD Master Audio™, and Dolby® Atmos



4K
@ 60Hz

18G

HDBT™
HDMI

SPECIFICATIONS

- ▶ Regulation: CE, RoHS, WEEE, EAC
- ▶ Enclosure: Tx unit: Brushed aluminum face with black metal backing
- ▶ Dimensions: 3.21" x 2.06" x 0.787" (Wall-plate)
- ▶ Product Weight: 0.7 lbs
- ▶ Packaging: 10.6" x 5.9" x 2.1" (270x150x55mm)
- ▶ Packaging Weight: 1.3 lbs

SYSTEM DESIGN EXAMPLE

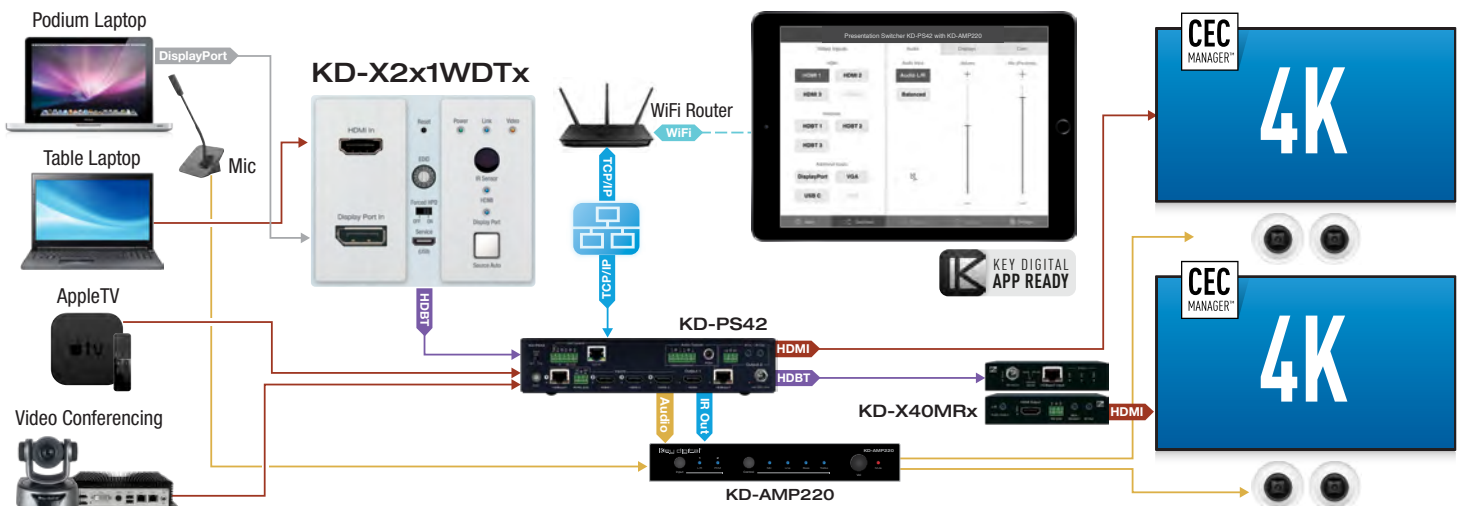



Key Digital Presentation Solutions are a family of products integrating a Soft-Codec Enabling System with HDBT/HDMI/Audio/Control hardware designed for professional audio video installations in conference rooms, board rooms, classrooms, lecture halls, auditoriums, and more.



KD-X2x1WVTx

2x1 4K/18G 40m HDBT PoH Wall Plate Switcher with HDMI & VGA, IR, RS-232. Transmitter Only.

KEY FEATURES

- **Presentation Switching:** 1 HDMI and 1 VGA with Analog Audio source selected by push button
- **Rx Options:** Native integration with KD-X40MRx black box HDBaseT Rx and KD-PS42 Presentation Switcher. Other Rx options available.
- **Ultra HD/4K:** Supports up to 4096x2160 or 3840x2160 24/25/30/60hz at 4:4:4 (signals up to 18Gbps bandwidth)
- **Auto-Sensing:** Automatic selection of newly detected source and switching from newly disconnected source when enabled
- **Converts:** VGA video and analog audio to HDMI
- **Video Scaling:** Aspect ratio, resolution set, image size, image position, image phase, and color tone processing of VGA signals ensures proper display
- **HDCP Licensing:** Fully licensed and compatible with HDCP 2.2
- **HDR10 and Dolby Vision:** More life-like images through a greater range of luminance levels
- **Power Over HDBaseT:** Wall-plate unit powered by Rx/Presentation Switch unit
- **Installation:** Tx unit designed for installation in standard US dual-gang box. Silver decora plate included.
- **Signal Extension:** For resolution and cable quality
 - » 4K/UHD (18G): Up to 40m / 131ft
 - » 1080p: Up to 70m / 230ft
- **Deep Color Support:** Up to UHD/4K 30Hz 4:4:4/12 bits or 60Hz 4:4:4/8 bit
- **Full Buffer System™:** Manages TMDS re-clocking / signal re-generation, HDCP authentication to source & display, EDID Control handshake, and Hot Plug Detection Voltage
- **EDID Management:** Internal library with 15 internal EDID handshakes including 4K with HDR in addition to native EDID data copied from the Rx display/device
- **VGA EDID:** Unique EDID handshake provided to VGA source and HDMI source



4K
@ 60Hz

18G



- **IR Sensor:** Wall-plate collects line-of-sight IR from remote(s) without external IR wiring
- **RS-232:** Bi-Directional control to/from Tx and Rx/Presentation Switch unit
- **Unit Control:** via USB for initial installation steps
- **Lossless Compressed Digital Audio:** Dolby® TrueHD, Dolby® Digital Plus, DTS-HD Master Audio™, and Dolby® Atmos

SPECIFICATIONS

- » Regulation: CE, RoHS, WEEE, EAC
- » Enclosure: Tx unit: Brushed aluminum face with black metal backing
- » Dimensions: 3.21" x 2.06" x 0.787" (Wall-plate)
- » Product Weight: 0.7 lbs
- » Packaging: 10.6" x 5.9" x 2.1" (270x150x55mm)
- » Packaging Weight: 1.3 lbs

SYSTEM DESIGN EXAMPLE

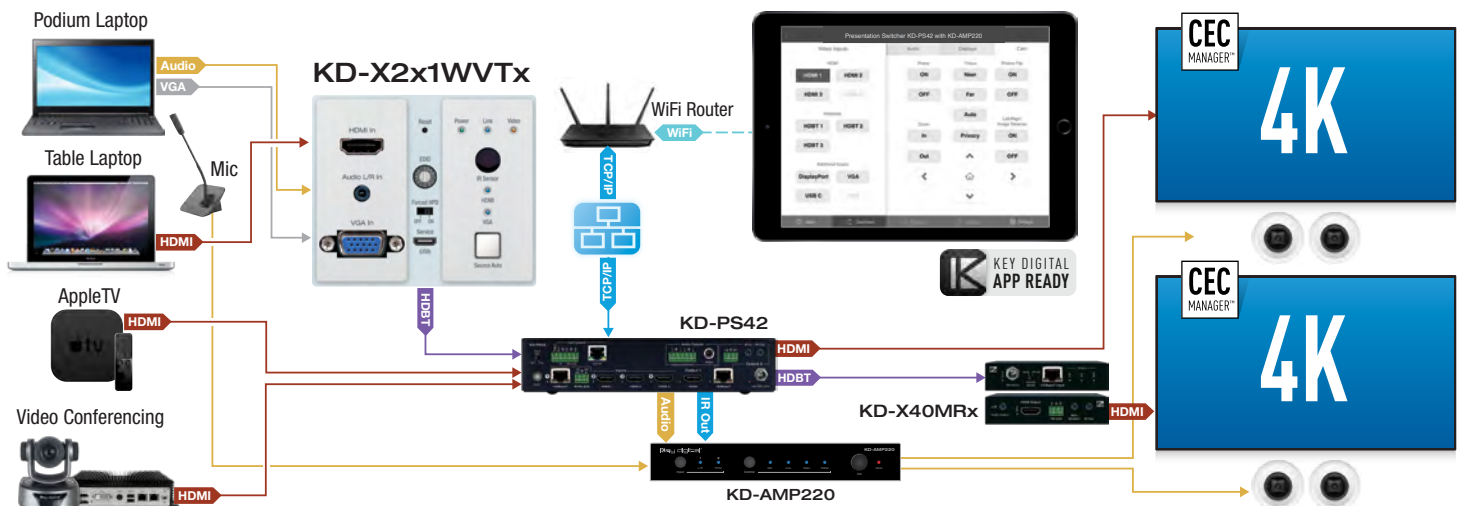



Key Digital Presentation Solutions are a family of products integrating a Soft-Codec Enabling System with HDBT/HDMI/Audio/Control hardware designed for professional audio video installations in conference rooms, board rooms, classrooms, lecture halls, auditoriums, and more.



KD-X100MRx

4K/18G HDBT Rx (100m) with USB, LAN, ARC, L/R Audio In, L/R Audio Output De-Embed, IR, RS-232.
Receiver Only.

KEY FEATURES

- › **Tx Options:** Sold a-la-carte to integrate natively with KD-X4x1WUTx and KD-X3x1WUTx wall-plate or KD-PS22UTx black box transmitters (sold separately).
- › **Soft-Codec Enabling System:** USB Host + Device ports on Rx and chosen wall-plate / Presentation Switch create connectivity hub for professional USB cameras and microphones, audio DSP, keyboard, mouse, or touchscreen display with connected computer
- › **Audio De-embedding:** Audio of the selected source is de-embedded at the unit's analog L/R connector
- › **Flexible Power over HDBaseT:** Rx powers Tx when integrated with KD-X4x1WUTx / KD-X3x1WUTx / KD-PS22UTx. Rx is powered by Tx when integrated with KD-UPS52U / KD-UPS72U
- › **CEC Manager™:** Passes through CEC control signals for monitors & projectors generated by KD-X4x1WUTx, KD-X3x1WUTx, KD-PS22UTx, KD-UPS52U, or KD-UPS72U
- › **PTZ USB Camera Integration:** Marries natively with KD-CAMUSB for full PTZ control via KD-App and more
- › **Ultra HD/4K:** Supports up to 4096x2160 or 3840x2160 24/25/30/60hz at 4:4:4 (signals up to 18Gbps bandwidth)
- › **HDCP Licensing:** Fully licensed and compatible with HDCP 2.2
- › **HDR10 and Dolby Vision:** More life-like images through a greater range of luminance levels
- › **Signal Extension:** For resolution and cable quality
 - › 4K/UHD (18G): Up to 100m / 328ft



SPECIFICATIONS

- › Regulation: CE, RoHS, WEEE, EAC
- › Enclosure: Black Metal

SYSTEM DESIGN EXAMPLE

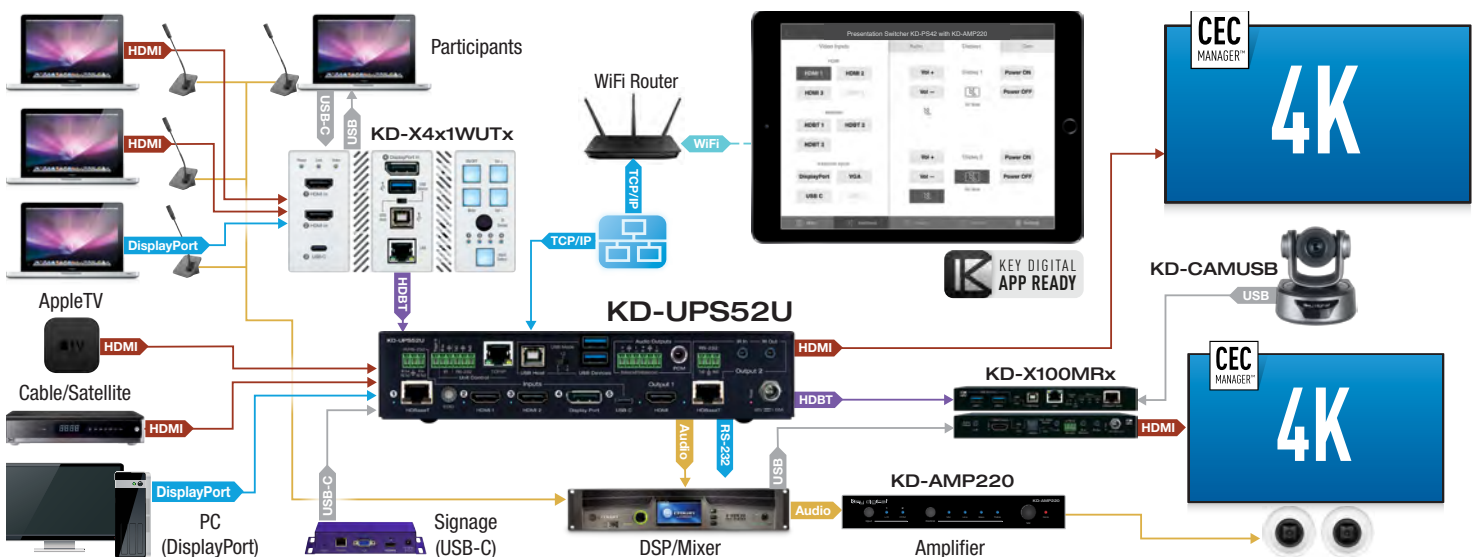



Key Digital Presentation Solutions are a family of products integrating a Soft-Codec Enabling System with HDBT/HDMI/Audio/Control hardware designed for professional audio video installations in conference rooms, board rooms, classrooms, lecture halls, auditoriums, and more.



KD-X40MRx

4K/18G HDBT Rx (40m) with L/R Audio De-Embed, IR, RS-232. Receiver Only.

KEY FEATURES

- › **Tx Options:** Sold a-la-carte to integrate natively with KD-X2x1WDTx and KD-X2x1WVTx wall-plate transmitters (sold separately).
- › **Flexible Power over HDBaseT:** Rx powers Tx when integrated with KD-X2x1WDTx / KD-X2x1WVTx. Rx is powered by Tx when integrated with KD-PS42 / KD-UPS42
- › **Audio De-embedding:** Audio of the incoming source is de-embedded at the unit's analog L/R audio connection for ease of integration with audio systems
- › **CEC Manager™:** Passes through CEC control signals for monitors & projectors when integrated with KD-PS42 / KD-UPS42.
- › **Ultra HD/4K:** Supports up to 4096x2160 or 3840x2160 24/25/30/60hz at 4:4:4 (signals up to 18Gbps bandwidth)
- › **4K Support:** 4096x2160 or 3840x2160 24/25/30/60hz at 4:4:4 (signals up to 18Gbps bandwidth)
- › **Low Profile:** Super slim chassis design
- › **Signal Extension:** For resolution and cable quality
 - › 4K/UHD (18G): Up to 40m / 131ft
 - › 1080p: Up to 70m / 230ft
- › **10G Pass-thru:** Mode enables uncompressed 10.2Gbps signal extension
- › **HDR10 and Dolby Vision:** More life-like images through a greater range of luminance levels
- › **HDCP 2.2:** Compliancy up to HDCP 2.2 and backward compliant
- › **Deep Color Support:** Up to UHD/4K 30Hz 4:4:4/12 bits or 60Hz 4:4:4/8 bit
- › **IR Sensor:** Sensor powering via +5V on IR In ports collects line-of-sight IR from remote(s) without external IR connecting block
- › **Up/Down IR:** Two channels of IR enable control to/from devices or control systems connected to Tx and Rx units
- › **RS-232:** Bi-Directional control to/from Tx and Rx unit on Phoenix connector



SPECIFICATIONS

- › Regulation: CE, RoHS, WEEE, EAC
- › Enclosure: Black Metal

SYSTEM DESIGN EXAMPLE

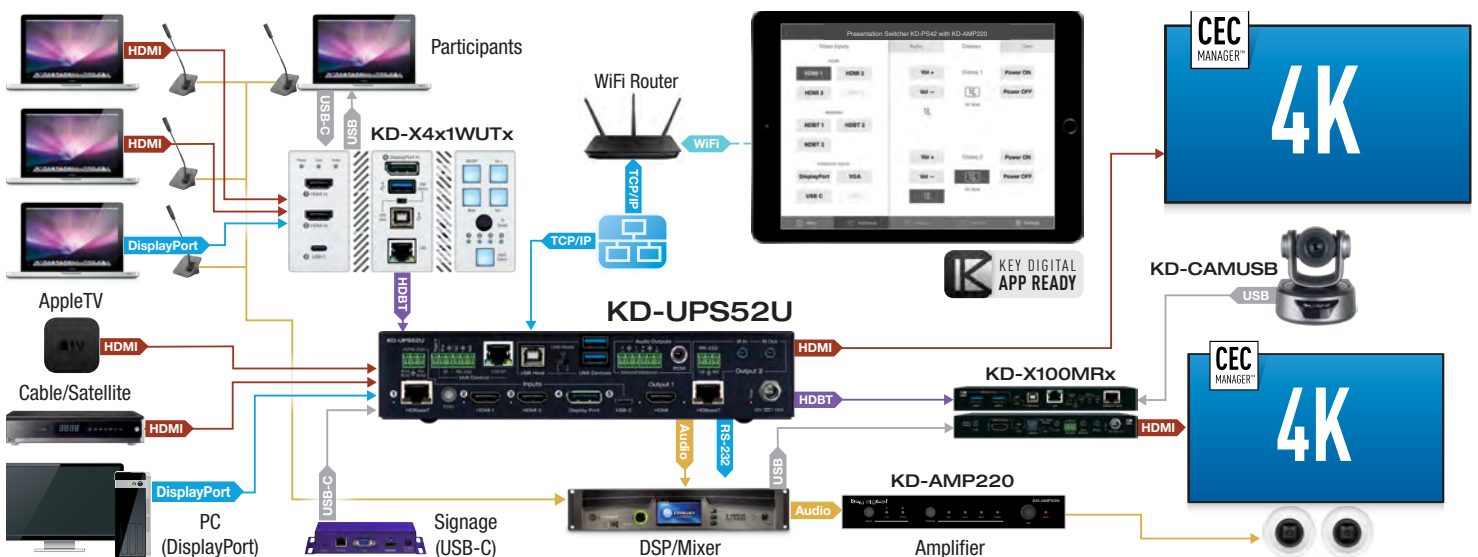



Key Digital Presentation Solutions are a family of products integrating a Soft-Codec Enabling System with HDBT/HDMI/Audio/Control hardware designed for professional audio video installations in conference rooms, board rooms, classrooms, lecture halls, auditoriums, and more.



KD-CAMUSB

PTZ USB Camera, IR/RS-232/Visca Controllable

KEY FEATURES

- ▶ **USB 2.0 Pan-Tilt-Zoom Camera:** Professional USB camera ideal for Video Conferencing and Capture applications in Huddle Spaces, Conference Rooms, Board Rooms, Lecture Halls, and more.
- ▶ **Compatible Operating Systems:** Generic USB Video Class Driver for effortless use on Windows 7, Windows 10, Mac OS X, and Linux machines
- ▶ **Video Conference Software Support:** Delivers professional PTZ features for popular video conference software such as Skype®, GoToMeeting®, Microsoft Teams®, Zoom™, RingCentral®, Google® Hangouts, and more
- ▶ **Soft Conference Enabling System:** Use with Key Digital Presentation Solutions family including KD-UPS52U, KD-PS22UTx, KD-X4x1WUTx, KD-X3x1WUTx, and KD-X100MRx to add USB plug-in wall plates, USB/KVM routing and extension, Digital Video switching, integration with professional audio visual systems (use external microphones as KD-CAMUSB does not feature built-in mic), TCP/IP and KD-App ready control.
- ▶ **Multiple Mounting Options:** Wall, and ceiling mounting hardware included. May also be table surface mounted.
- ▶ **Recall & Store Position Presets:** Up to 255 presets may be created, with up to 12 presets accessed via IR remote control on Home, Privacy, and numeric buttons.
- ▶ **Auto Focus:** Fast and accurate auto focus via leading auto focus algorithm
- ▶ **Video Resolutions:** From 320x240p @ 30fps up to 1920x1080p @ 30fps. Adjustable via Windows camera viewer and conferencing software camera settings panels
- ▶ **Pan-Tilt-Zoom:** Pan = $\pm 170^\circ$. Tilt = -30° to $+90^\circ$. Zoom = 10x
- ▶ **User-Friendly IR Remote:** Provides intuitive and ergonomic control
- ▶ **RS-232:** Bi-Directional control to/from KD-CAMUSB or via Key Digital Presentation Solutions Extender & Switcher units
- ▶ **VISCA Controllable:** Responds to VISCA protocol for control by PTZ camera control consoles. Supports addressing for multi-camera systems.



- ▶ **Control System Support:** Fully controllable by all RS-232 supported control systems via open API: Compass Control® Pro, AMX®, Crestron®, KNX®, RTI®, Savant, URC®, Leviton® etc. TCP/IP controllable when integrated with supported Key Digital Presentation Solutions Extenders and Switchers.
- ▶ **KD-App Ready:** When integrated with supported Key Digital Presentation Solutions Extenders and Switchers including KD-UPS52U, KD-X4x1WUTx, and KD-X100MRx. Pre-built GUI populates offering PTZ controls as source selection and display/projector controls via CEC Manager™.

SPECIFICATIONS

- » Regulation: CE, RoHS, WEEE, EAC
- » Enclosure: Silver Plastic

SYSTEM DESIGN EXAMPLE

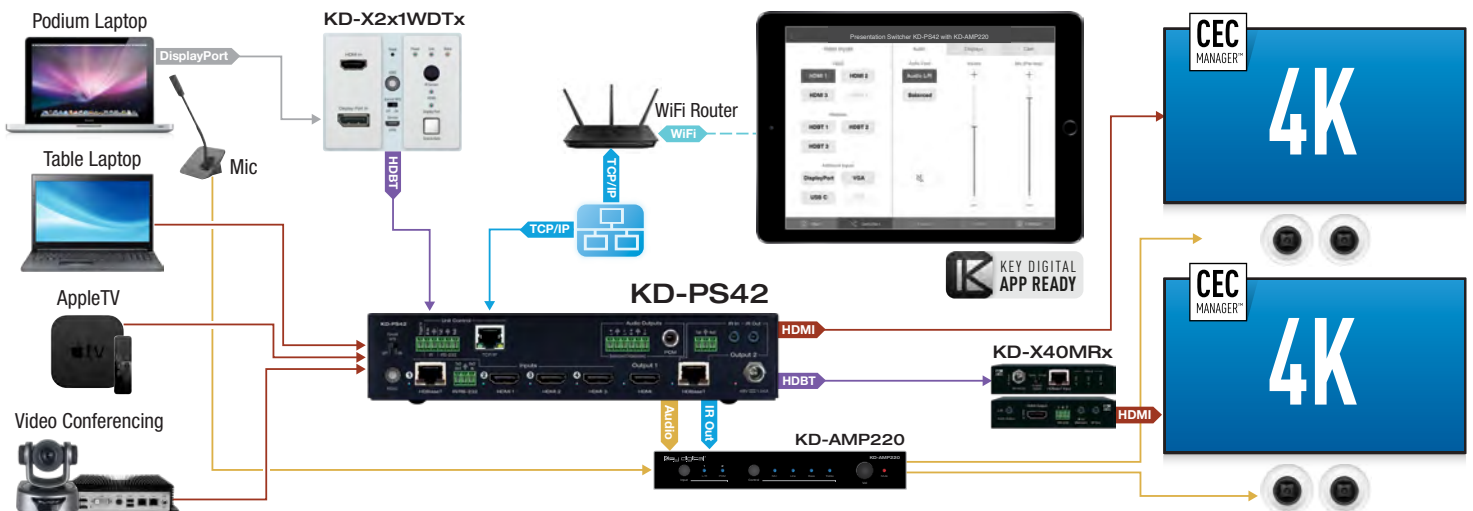

Video Wall Processor

Key digital PRO
 MANAGEMENT SOFTWARE

KEY DIGITAL
 APP READY

KD-VW4x4Pro

4x4 Outputs Video Wall Processor, supports Seamless Matrix Switching

KEY FEATURES

- › **HDMI Matrix Switching:** 4 HDMI/Analog sources to 4 HDMI outputs, independent when in matrix mode
- › **Seamless Switching:** Un-interrupted screen transitions during source selections
- › **Video Wall Processing:** Transform consumer and professional displays into a video wall with eight **video wall modes**:
 - › Horizontal (4): 1x4 Rotated, 1x4, 1x3, and two sets of 1x2
 - › Vertical (3): 4x1, 3x1, and two sets of 2x1
 - › 2x2
- › **Bezel Control:** Create a fluid screen transition by removing pixels from top, bottom, left, and right border independently
- › **Panel Flip:** Enables use of consumer displays by mounting top row upside down
- › **Resolution Support:** Supports SD, HD, and VESA input resolutions up to 1080p / 1920x1200 on HDMI and analog video Inputs
- › **EDID:** Internal library with 5 default EDID configurations for each input, in addition to native EDID data for any Output/Display
- › **Full Buffer™ Technology:** Full buffering of HDCP and EDID, for the fastest possible switching and viewing of any source/input to any display/output, regardless of multiple output viewing relation
- › **TMDS re-clocking:** Support for long HDBaseT/CAT5e/6 or HDMI connections and many layers of connectivity.
- › **Deep Color Support:** Up to 12 bits/color



- › **Control:** Front panel buttons, Serial IR, Optical IR, RS-232, and TCP-IP, including video wall mode select, matrix switching, EDID Control and discrete on and off via IR
- › **Control System Support:** Compatible with Compass Control® Pro, AMX®, Control4®, Crestron®, KNX®, RTI®, Savant, URC®, Leviton®, etc.

SPECIFICATIONS

- › **Input (Each):** 1 HDMI connector, Type A, 19 pin female; 1 HD analog video 15-pin female, 1 analog audio connector, 3.5mm stereo female
- › **Output (Each):** 1 HDMI connector, Type A, 19 pin female
- › **Power Supply:** KD-PS12V3A, 12V/3A, 100-240VAC, 50-60Hz, NEMA 1-15P Cord
- › **Rack Mount:** 1U, full rack-width (rack ears included)
- › **Product:** 17.25" x 7.1" x 1.75"; Weight: 6.5 lbs
- › **Packaging:** 22.8" x 8.5" x 3.2"; Weight 8 lbs
- › **Regulation:** CE, RoHS, WEEE, EAC
- › **Enclosure:** Black Metal

VIDEO WALL MODES



SYSTEM DESIGN EXAMPLE

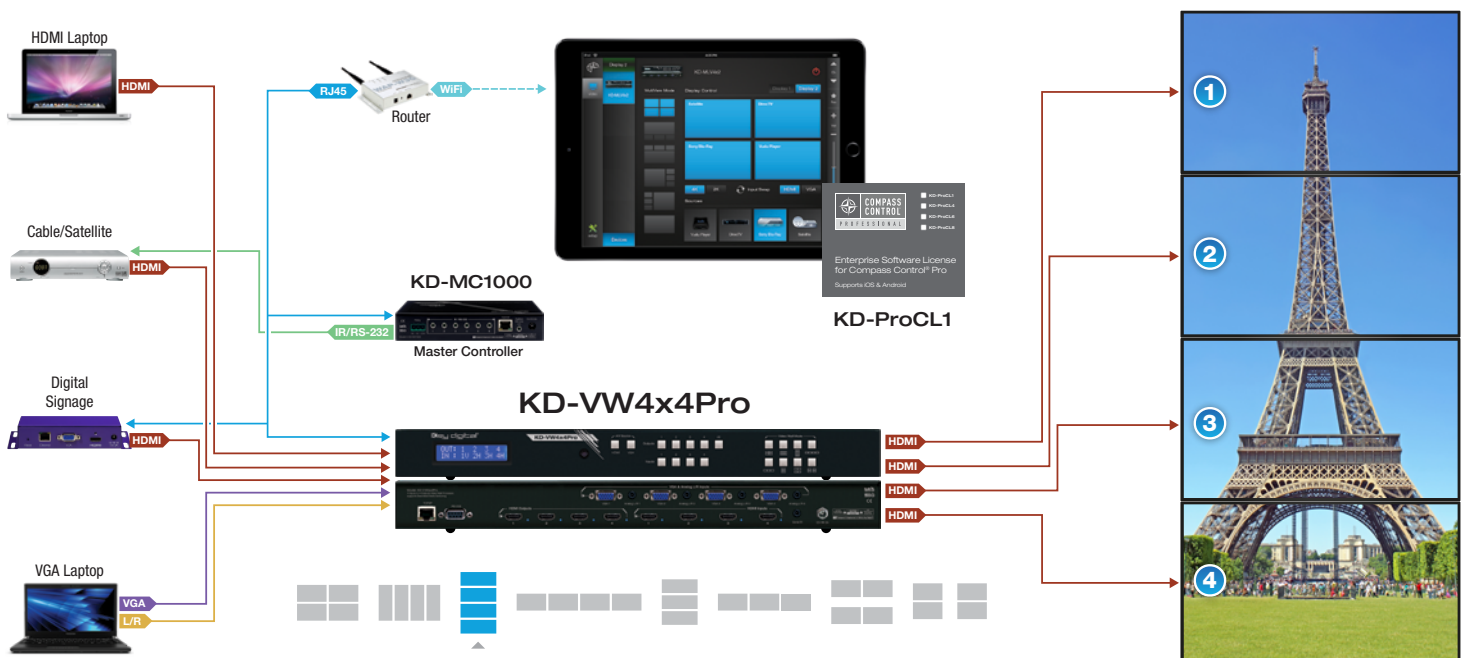

KD-MLV4x2Pro

4x2 4K POH/HDBaseT/HDMI/VGA Multi-View Seamless Presentation Matrix Switcher.
(Includes 1 Rx Extender)

KEY FEATURES

- ▶ **Multi-View Window Processing:** Create & store custom multi-view layouts, recall custom presets in 1080p (2K) Multi-view mode
 - » **Quadrant Mode (4K or 2K):** Independent outputs in four equally-sized windows
 - » **Multi-view Mode (2K):** Linked/mirrored outputs in customized screen layout
- ▶ **Seamless Switching:** Un-interrupted screen transitions during source selections
- ▶ **Independent Matrix Switching:** In full-screen and quadrant modes, linked/mirrored in multi-view mode
- ▶ **Image Layering:** Stack images with customizable priority settings
- ▶ **Window Transparency and Border:** View content through each other and choose window bezel width and coloring
- ▶ **Multi-format Switch:**
 - » **Input:** 2 HDMI, 2 HDMI or Analog video, all with external audio
 - » **Output:** 1 HDMI and 1 HDBaseT output. Rx unit included
- ▶ **HDBaseT Built-In:** Included KD-X222PORx unit is powered by at KD-MLV4x2Pro
- ▶ **Signal Extension:**
 - » Up to 200 feet @ 1080p/60, 1080p/24, 1080i, 720p with third-party CAT5e/6
 - » Up to 125 feet @ 4096x2160 30Hz [4:4:4] 8bit with third-party CAT5e/6
- ▶ **Ultra HD/4K Up-scaling:** Outputs independently upscale to 4096x2160 30Hz [4:4:4] 8bit in 4K Quadrant mode
- ▶ **HDCP 2.2 Licensing:** Fully licensed and compatible with HDCP 2.2
- ▶ **Resolution Support:** Supports SD, HD, and VESA input resolutions up to 1080p / 1920x1200 on HDMI and analog video Inputs. Outputs fixed to 1080p or 4K.
- ▶ **Audio De-Embedding:** Audio from the selected input can be de-embedded through the Coax digital (PCM) output in addition to the HDMI output
- ▶ **Dolby Digital & DTS Audio:** Supports 2-channel and multi-channel audio formats up to 5.1 Dolby® / DTS™ lossless compressed digital surround sound
- ▶ **Independent Video & Audio:** Listen to any audio source while in quadrant or multi-view modes
- ▶ **Analog to Digital Video Conversion:** Analog video input ports

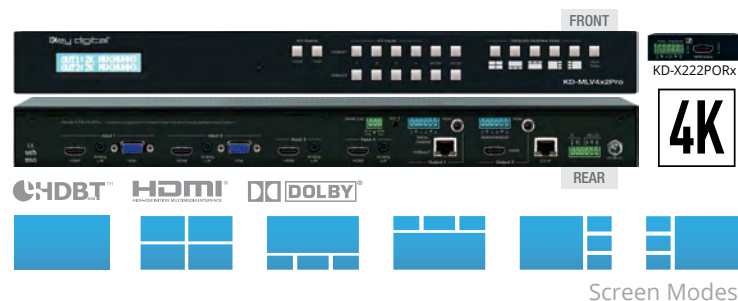

Screen Modes

- support VGA / DB15 or Component / YpbPr signal types
- ▶ **Full Buffer System™:** Manages TMDS re-clocking / signal re-generation, HDCP authentication to source & display, and EDID Control handshake
- ▶ **EDID:** Internal library with 5 default EDID configurations for input, in addition to native EDID data for any Output / Display
- ▶ **TMDS Re-clocking:** Support for long HDMI connectivity using Key Digital® HDMI cables
- ▶ **Control:** Front panel buttons, IR, RS-232, TCP/IP and Web Control
- ▶ **Deep Color Support:** Up to 12 bits/color
- ▶ **Web Control Interface:** Reduces installation time and provides basic and advanced video and audio setup
- ▶ **Control System Support:** Compatible with Compass Control® Pro, AMX®, Control4®, Crestron®, KNX®, RTI®, Savant, URC®, Honeywell®, HAI®, Leviton®, etc.
- ▶ **Key Digital® App Ready:** Can be controlled over TCP/IP via Key Digital® App

SPECIFICATIONS

- ▶ **Power Supply:** KDPS60W12VQ, 12V/5A, screw-in type
- ▶ **Rack Mount:** 1U, full rack-width (rack ears included)
- ▶ **Enclosure:** Black Metal ▶ **Regulation:** CE, RoHS, WEEE, EAC
- ▶ **Product:** 17.25" x 8.875" x 1.75"; Weight: 6.5 lbs
- ▶ **Packaging:** 18.5" x 13" x 3.5"; Weight 8.8 lbs



DIGITAL SIGNAGE

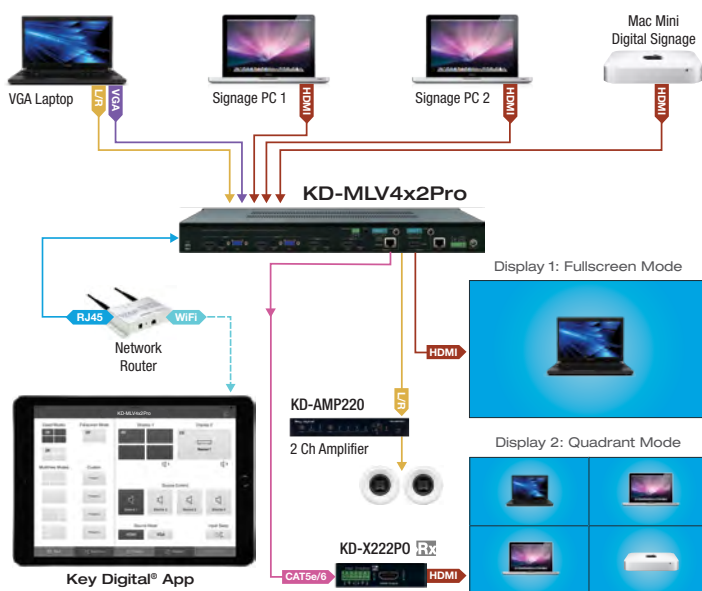

BAR/RESTAURANT

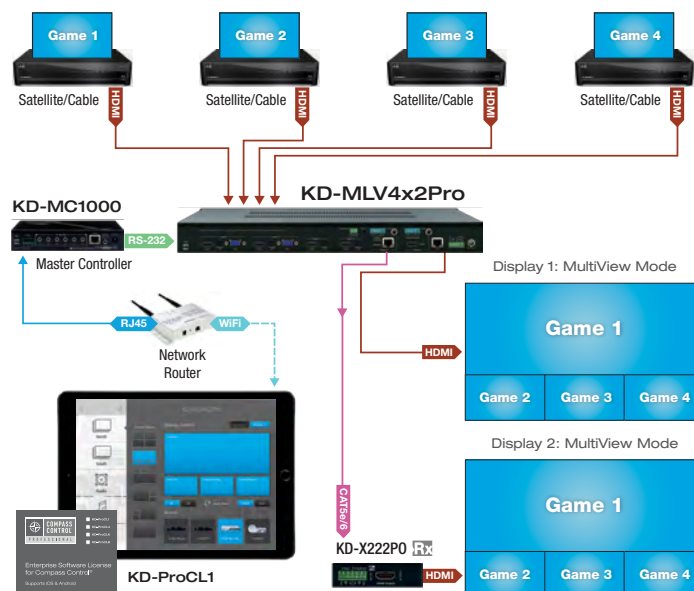

KD-Pro8x8D

8x8 4K HDBaseT/HDMI/POH Matrix Switcher, Integrated Audio, DSP/De-embedding of Analog L/R Balanced/Unbalanced, Digital Coaxial Audio, ARC. (Includes 8 Rx Extenders: 6 Standard Range & 2 Long Range)

KEY FEATURES

- ▶ **4K/UHD Resolution:** Supports signals up to 4096x2160 60Hz [4:2:0] 8bit, 4096x2160 30Hz [4:2:2] 12bit, and 4096x2160 30Hz [4:4:4] 8bit
- ▶ **Bandwidth:** 10.2Gbps supports UHD/4K resolutions with HDR via EDID handshaking
- ▶ **Simultaneously Active:** 8 HDBaseT (CAT5e/6 RJ45) and 8 HDMI outputs with fully automatic CAT5e/6 cable equalization. Supports up to 16 displays (8 mirrored)
- ▶ **HDBaseT Rx Included:** 8 total Rx extenders integrate with built-in HDBaseT Tx output ports: (6) Standard Range KD-X88SHRx, (2) Long Range KD-X88LGRx
- ▶ **Signal Extension via KD-X88SHRx:**
 - » Up to 125 feet @ 4K/Ultra HD;
 - » Up to 200 feet @ 1080p/60/24, 1080i, 720p
- ▶ **Signal Extension via KD-X88LGRx:**
 - » Up to 300 feet @ 4K/Ultra HD;
 - » Up to 500 feet @ 1080p/60/24, 1080i, 720p
- ▶ **HDR (High Dynamic Range):** More life-like images through a greater range of luminance levels
- ▶ **HDCP 2.2 and HDMI Licensing:** Fully licensed and compatible with HDCP 2.2 and HDMI latest technologies
- ▶ **Deep Color Support:** Up to 12 bits/color
- ▶ **Audio Return Channel:** Audio may be returned from display to respective audio output
- ▶ **Audio De-Embedding:** Audio from the selected HDMI input may be de-embedded through the Coax digital (PCM) and analog L/R balanced/unbalanced output
- ▶ **Audio DSP:** Variable level settings for volume, muting, 3-band EQ, balance, and lip-sync delay per output
- ▶ **Full Buffer™ Technology:** Full buffering of HDCP and EDID, for the fastest possible switching and viewing of any source/input to any display/output, regardless of multiple output viewing relation
- ▶ **EDID Control:** Internal library with 15 default EDID configurations for each input, in addition to native EDID data for any Output/Display
- ▶ **TMDS Re-clocking:** Support for long HDBaseT and HDMI runs and many layers of connectivity



- ▶ **Voltage Control:** Two dedicated 3-pin relays and any control I/O ports may be used as a voltage trigger
- ▶ **Lossless Compressed Digital Audio:** Dolby® TrueHD, Dolby® Digital Plus, Dolby® Atmos and DTS-HD Master Audio™
- ▶ **Control Routing:** Enables bi-directional IR/RS-232 control signal extension adding 36 ports to control system
- ▶ **Control Integration:** TCP/IP, RS-232, and USB with full bi-directional operation, front panel push buttons and LEDs, front/rear optical IR, serial IR
- ▶ **Control System Support:** Key Digital® App ready, Compass Control® Pro ready, KD-Wizard® ready. Fully controllable by all IR, RS-232, TCP/IP supported control systems via open API: AMX®, Crestron®, Control4®, KNX®, RTI®, Savant, URC®, Leviton® etc.
- ▶ **Key Digital® App Ready:** Scan & detect population for pre-built GUI and TCP/IP control via Key Digital® App

SPECIFICATIONS

- » Power: Main KD-PS6V11A - 6V/11.6A (70W); KD-XSWRx - 12V/6.6A (80W)
- » Regulation: CE, RoHS, WEEE, EAC
- » Rack Mount: 2U, Full Rack Width (rack ears included)
- » Enclosure: Black Metal
- » Product: 17.3" x 6.6" x 3.46" Weight: 6.6 lb.
- » Packaging: 18.9" x 10.7" x 8.6" Weight: 16.5 lb.

SYSTEM DESIGN EXAMPLE

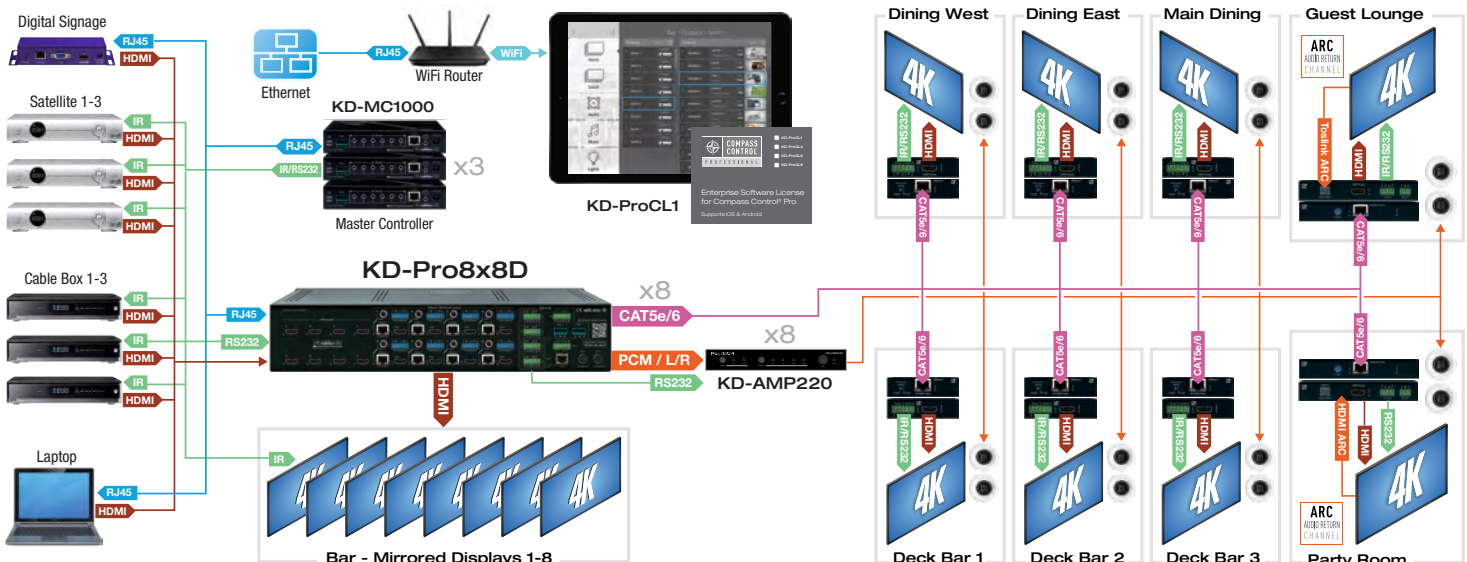

KD-MS4x4G

4x4 4K/18G HDMI Matrix Switchers, with Independent Audio Switching, Balanced/Unbalanced Audio, Audio De-embedding of Analog L/R/PCM

KEY FEATURES

- » **HDMI Matrix Switching:** 4 HDMI sources to 4 HDMI outputs
- » **Ultra HD/4K Support:** 4096x2160 or 3840x2160 24/25/30/60hz at 4:4:4 (signals up to 18Gbps bandwidth)
- » **HDCP Licensing:** Fully licensed and compatible with HDCP 2.2
- » **HDR10 (High Dynamic Range):** More life-like images through a greater range of luminance levels
- » **Resolution Support:** Supports all SD, HD, and VESA (VGA, SVGA, XGA, WXGA, SXGA, UXGA) up to 4096x2160p
- » **Deep Color Support:** Up to UHD/4K 60Hz 4:2:0/12 bits, 60Hz 4:2:2/12 bits
- » **Independent Audio and Video Matrix:** Output HDMI and Audio ports may switch together or independently
- » **Full Buffer System™:** Manages TMDS re-clocking / signal re-generation, HDCP authentication to source & display, and EDID Control handshake
- » **EDID:** Internal library with 15 internal EDID configurations per input, in addition to native EDID data for any Output/Display
- » **TMDS re-clocking:** Long HDMI connectivity support with Key Digital® HDMI cables
- » **Lossless Compressed Digital Audio:** Dolby® TrueHD, Dolby® Digital Plus, DTS-HD Master Audio™, and Dolby® Atmos
- » **Control:** Front panel buttons/LEDs, Serial IR, Optical IR, RS-232 Control, and TCP/IP Control
- » **Control System Support:** Key Digital® app ready. Key Digital Management Software™ Pro (KDMS™ Pro) ready, Compass Control® Pro ready. Fully controllable by all IR, RS-232, and TCP/IP supported control systems via open API.
- » **Key Digital® App & KDMS® Pro Ready:** Scan & detect population for pre-built GUI and TCP/IP control via Key Digital® iOS App and Key Digital Management Software™ Pro (KDMS™ Pro) PC Software



SPECIFICATIONS

- » Input (Each): 1 HDMI Connector, Type A, 19 Pin Female
- » Output (Each): 1 HDMI Connector, Type A, 19 Pin Female
- » Output (Each): Balanced/unbalanced line level audio on 6-pin terminal block. Drives 2VRMS line audio input with a sampling rate of 192KHz
- » Output (each): RCA female for digital audio following SPDIF format (IEC 60958). Supports sampling rate up to 192KHz
- » Power: 12V/3.3A (40W) AC Power Supply with Grounded, 2.1mm ID DC Power Jack with Screw In Type.
- » Regulation: CE, RoHS, WEEE, EAC
- » Rack Mount: 1U, 1 Rack Width (rack ears included)
- » Enclosure: Black Metal
- » Dimensions: L = 17.32" W = 5.78" H = 1.72"
- » Shipping Carton Dimensions: L = 23.4" W = 8.54" H = 2.36"
- » Product Weight: 6 lb
- » Shipping Weight: 9 lb
- » Accessories: IR Remote, UL Certified Power Supply

SYSTEM DESIGN EXAMPLE

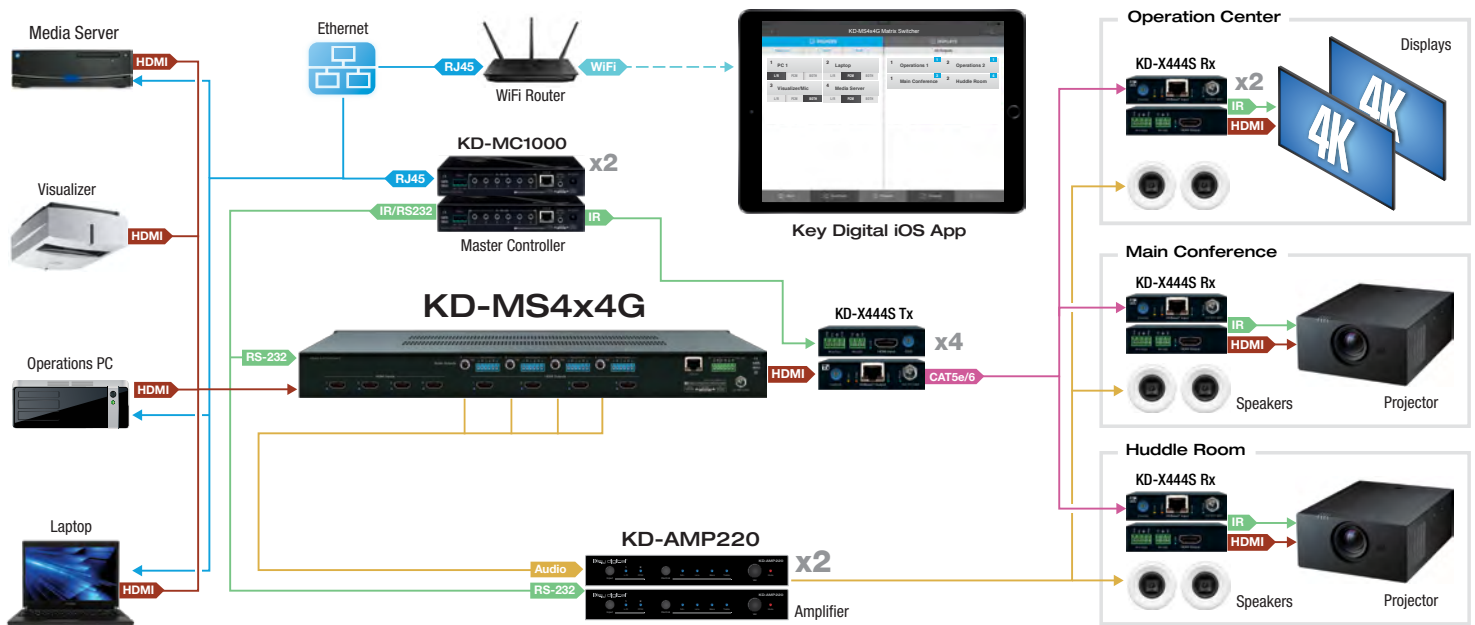

KD-MS8x8G

8x8 4K/18G HDMI Matrix Switcher, with Independent Audio Switching, Balanced/Unbalanced Audio, Audio De-embedding of Analog L/R/PCM

KEY FEATURES

- » **HDMI Matrix Switching:** 8 HDMI sources to 8 HDMI outputs
- » **Ultra HD/4K Support:** 4096x2160 or 3840x2160 24/25/30/60hz at 4:4:4 (signals up to 18Gbps bandwidth)
- » **HDCP Licensing:** Fully licensed and compatible with HDCP 2.2
- » **HDR10 (High Dynamic Range):** More life-like images through a greater range of luminance levels
- » **Resolution Support:** Supports all SD, HD, and VESA (VGA, SVGA, XGA, WXGA, SXGA, UXGA) up to 4096x2160p
- » **Deep Color Support:** Up to UHD/4K 60Hz 4:2:0/12 bits, 60Hz 4:2:2/12 bits
- » **Independent Audio and Video Matrix:** Output HDMI and Audio ports may switch together or independently
- » **Full Buffer System™:** Manages TMDS re-clocking / signal re-generation, HDCP authentication to source & display, and EDID Control handshake
- » **EDID:** Internal library with 15 internal EDID configurations per input, in addition to native EDID data for any Output/Display
- » **TMDS re-clocking:** Long HDMI connectivity support with Key Digital® HDMI cables
- » **Lossless Compressed Digital Audio:** Dolby® TrueHD, Dolby® Digital Plus, DTS-HD Master Audio™, and Dolby® Atmos
- » **Control:** Front panel buttons/LEDs, Serial IR, Optical IR, RS-232 Control, and TCP/IP Control
- » **Control System Support:** Key Digital® app ready. Key Digital Management Software™ Pro (KDMS™ Pro) ready, Compass Control® Pro ready. Fully controllable by all IR, RS-232, and TCP/IP supported control systems via open API.
- » **Key Digital® App & KDMS® Pro Ready:** Scan & detect population for pre-built GUI and TCP/IP control via Key Digital® iOS App and Key Digital Management Software™ Pro (KDMS™ Pro) PC Software



SPECIFICATIONS

- » Input (Each): 1 HDMI Connector, Type A, 19 Pin Female
- » Output (Each): 1 HDMI Connector, Type A, 19 Pin Female
- » Output (Each): Balanced/unbalanced line level audio on 6-pin terminal block. Drives 2VRMS line audio input with a sampling rate of 192KHz
- » Output (each): RCA female for digital audio following SPDIF format (IEC 60958). Supports sampling rate up to 192KHz
- » Power: 12V/3.3A (40W) AC Power Supply with Grounded, 2.1mm ID DC Power Jack with Screw In Type.
- » Regulation: CE, RoHS, WEEE, EAC
- » Rack Mount: 1U, 1 Rack Width (rack ears included)
- » Enclosure: Black Metal
- » Dimensions: L = 17.32" W = 7.27" H = 1.72"
- » Shipping Carton Dimensions: L = 23.4" W = 8.54" H = 2.36"
- » Product Weight: 6 lb
- » Shipping Weight: 9 lb
- » Accessories: IR Remote, UL Certified Power Supply

SYSTEM DESIGN EXAMPLE

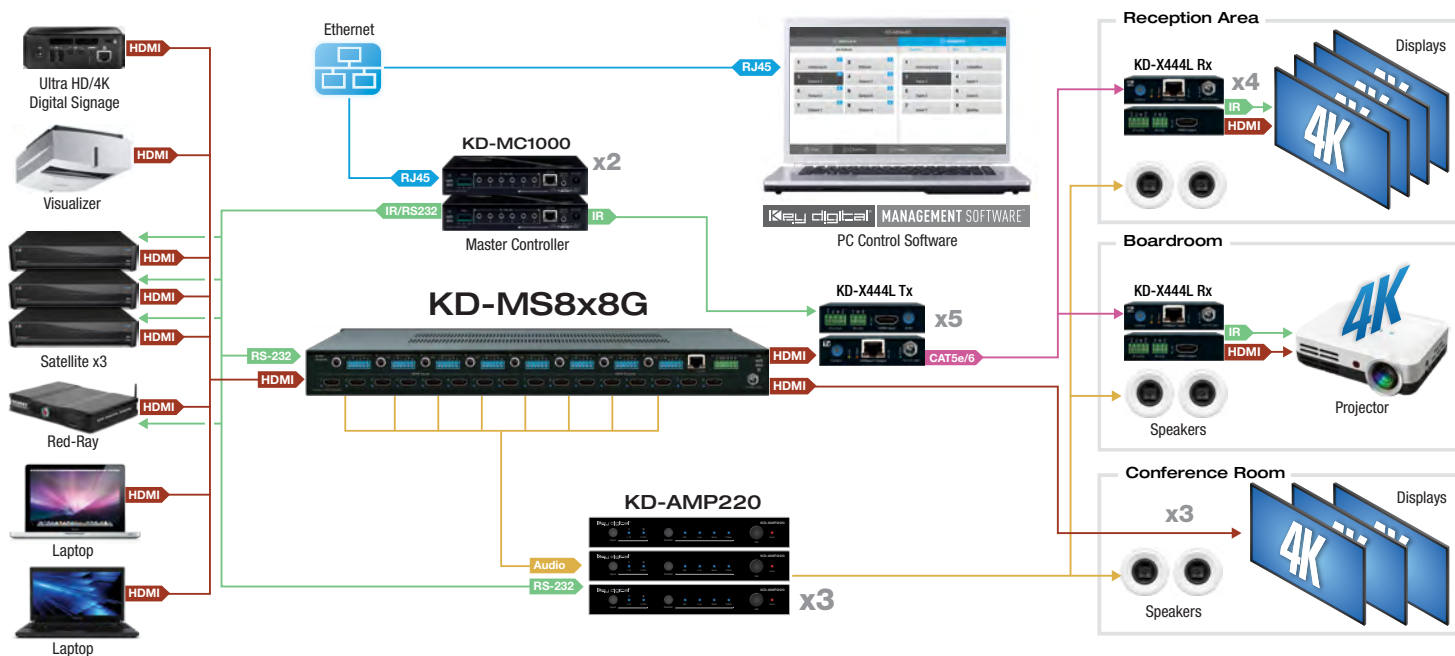

KD-Pro2x1X

2x1 4K/18G HDMI Switcher with Optical, PCM, L/R, and Balanced/Unbalanced Audio, IP Control

KEY FEATURES

- › **HDMI Switching:** 2 HDMI sources to 1 HDMI output/display
- › **Ultra HD/4K:** Supports up to 4096x2160 or 3840x2160 24/25/30/60hz at 4:4:4 (signals up to 18Gbps bandwidth)
- › **HDCP Licensing:** Fully licensed and compatible with HDCP 2.2
- › **HDR10 and Dolby Vision:** More life-like images through a greater range of luminance levels
- › **Audio De-embedding:** Audio of the selected HDMI input is de-embedded at the analog (3.5mm stereo & L/R balanced/unbalanced) and digital (optical & PCM) connectors
- › **Key Digital[®] App Ready:** Scan & detect population for pre-built GUI and TCP/IP control via Key Digital[®] App
- › **KD-AMP220 Control Mode:** Command forward to KD-Amp220 for an all-in-one user-friendly control UI of video switching, audio and speech enforcement
- › **Auto-Sensing:** Automatic selection of newly detected source and switching from newly disconnected source via hot plug detection voltage when enabled
- › **Resolution Support:** Supports all SD, HD, and VESA (VGA, SVGA, XGA, WXGA, SXGA, UXGA) up to 4096x2160p.
- › **Deep Color Support:** Up to UHD/4K 30Hz 4:4:4/12 bits or 60Hz 4:4:4/8 bit
- › **Full Buffer System[™]:** Manages TMDS re-clocking / signal re-generation, HDCP authentication to source & display, and EDID Control handshake
- › **EDID Management:** Internal library with 15 internal EDID handshakes including 4K with HDR in addition to native EDID data copied from the output/display
- › **Lossless Compressed Digital Audio:** Dolby[®] TrueHD, Dolby[®] Digital Plus, Dolby[®] Atmos and DTS-HD Master Audio[™]



SPECIFICATIONS

- › Input (Each): HDMI Connector, Type A, 19 Pin Female
- › Output: HDMI Connector, Type A, 19 Pin Female
- › Power Supply: KD-PS5V2ASC, 5V/2.4A, 100-240VAC, 50-60Hz, Interchangeable head, screw-in connector
- › Regulation: CE, RoHS, WEEE, EAC
- › Enclosure: Black Metal
- › Product Dimensions: 8.25" x 4.0" x 1.7"
- › Packaging Dimensions: 10.75" x 8.9" x 2.2"
- › Product Weight: 0.9 lb
- › Shipping Weight: 2 lb

SYSTEM DESIGN EXAMPLE

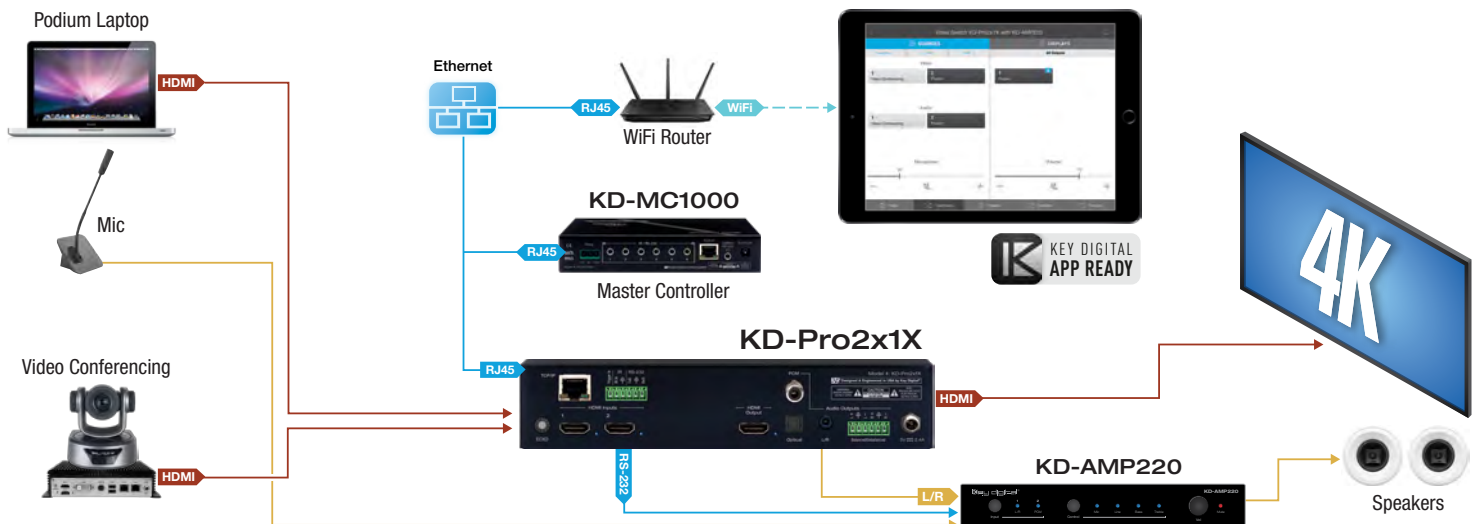

KD-Pro4x1X

4x1 4K/18G HDMI Switcher with Optical, PCM, L/R, and Balanced/Unbalanced Audio, IP Control

KEY FEATURES

- › **HDMI Switching:** 4 HDMI sources to 1 HDMI output/display
- › **Ultra HD/4K:** Supports up to 4096x2160 or 3840x2160 24/25/30/60hz at 4:4:4 (signals up to 18Gbps bandwidth)
- › **HDCP Licensing:** Fully licensed and compatible with HDCP 2.2
- › **HDR10 and Dolby Vision:** More life-like images through a greater range of luminance levels
- › **Audio De-embedding:** Audio of the selected HDMI input is de-embedded at the analog (3.5mm stereo & L/R balanced/unbalanced) and digital (optical & PCM) connectors
- › **Key Digital[®] App Ready:** Scan & detect population for pre-built GUI and TCP/IP control via Key Digital[®] App
- › **KD-AMP220 Control Mode:** Command forward to KD-Amp220 for an all-in-one user-friendly control UI of video switching, audio and speech enforcement
- › **Auto-Sensing:** Automatic selection of newly detected source and switching from newly disconnected source via hot plug detection voltage when enabled
- › **Resolution Support:** Supports all SD, HD, and VESA (VGA, SVGA, XGA, WXGA, SXGA, UXGA) up to 4096x2160p.
- › **Deep Color Support:** Up to UHD/4K 30Hz 4:4:4/12 bits or 60Hz 4:4:4/8 bit
- › **Full Buffer System[™]:** Manages TMDS re-clocking / signal re-generation, HDCP authentication to source & display, and EDID Control handshake
- › **EDID Management:** Internal library with 15 internal EDID handshakes including 4K with HDR in addition to native EDID data copied from the output/display
- › **Lossless Compressed Digital Audio:** Dolby[®] TrueHD, Dolby[®] Digital Plus, Dolby[®] Atmos and DTS-HD Master Audio[™]



SPECIFICATIONS

- › **Input (Each):** HDMI Connector, Type A, 19 Pin Female
- › **Output:** HDMI Connector, Type A, 19 Pin Female
- › **Power Supply:** KD-PS5V2ASC, 5V/2.4A, 100-240VAC, 50-60Hz, Interchangeable head, screw-in connector
- › **Regulation:** CE, RoHS, WEEE, EAC
- › **Enclosure:** Black Metal
- › **Product Dimensions:** 8.25" x 4.0" x 1.7"
- › **Packaging Dimensions:** 10.75" x 8.9" x 2.2"
- › **Product Weight:** 0.9 lb
- › **Shipping Weight:** 2 lb

SYSTEM DESIGN EXAMPLE

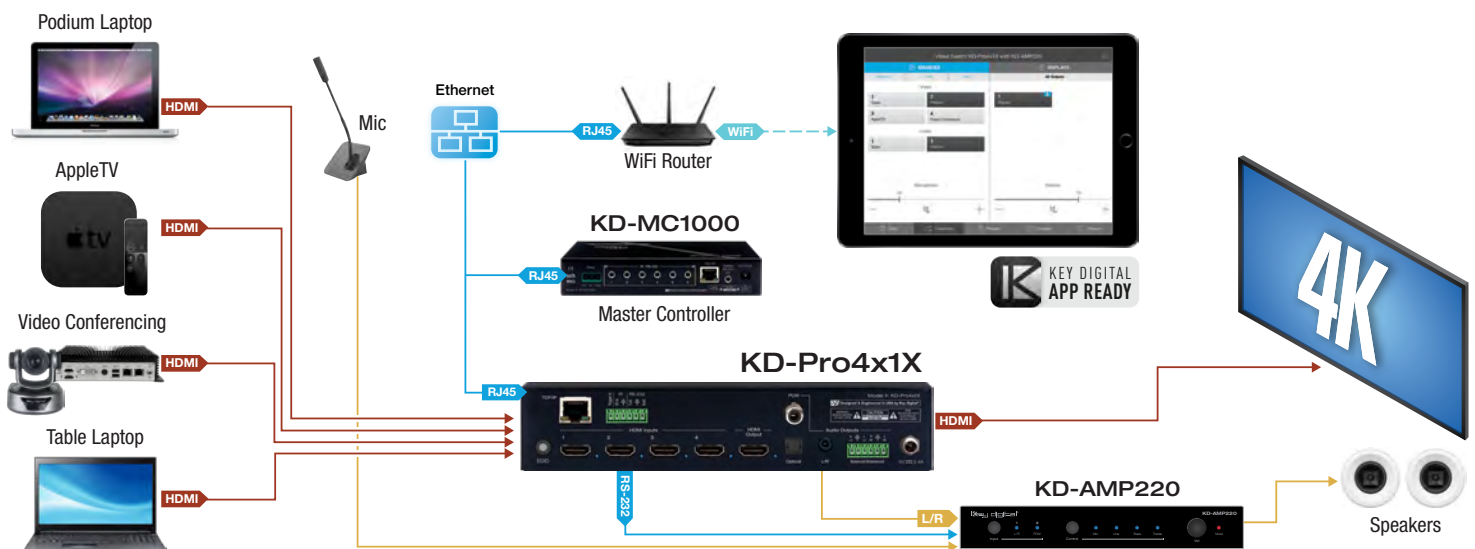

KD-Pro2x1

2x1 4K/18G HDMI Switcher with Audio De-embedding of Analog L/R Balanced/Unbalanced & Digital Coaxial Audio, supports HDR10, HDCP2.2

KEY FEATURES

- » **HDMI Switching:** 2 HDMI sources to 1 HDMI output
- » **4K Support:** 4096x2160 or 3840x2160 30Hz at 4:4:4 and 60Hz at 4:4:4
- » **18 Gbps Bandwidth:** High Speed / Performance for latest HDMI standards
- » **HDR10 (High Dynamic Range):** More life-like images through a greater range of luminance levels
- » **HDCP 2.2 and HDMI Licensing:** Fully licensed and compatible with HDCP 2.2 and HDMI latest technologies
- » **Deep Color Support:** Up to UHD/4K 30Hz 4:4:4/12 bits or 60Hz 4:4:4/8 bit
- » **Audio De-Embedding:** Audio from the selected HDMI input is de-embedded through the Coax digital (PCM) or Analog L/R Balanced/Unbalanced
- » **Full Buffer System™:** Manages TMDS re-clocking / signal re-generation, HDCP authentication to source & display, and EDID Control handshake
- » **EDID:** Internal library with 15 default EDID handshakes for inputs, in addition to native EDID data for Output/Display
- » **TMDS re-clocking:** Support for long HDMI connectivity using Key Digital[®] HDMI cables
- » **Lossless Compressed Digital Audio:** Dolby[®] TrueHD, Dolby[®] Digital Plus, DTS-HD Master Audio™, and Dolby[®] Atmos
- » **Control:** Front panel buttons/LEDs, Trigger In, Serial IR, Optical IR, RS-232 Control, and TCP/IP Control
- » **Control System Support:** Key Digital[®] App ready. Compass Control[®] ready. Fully controllable by all IR, RS-232, and TCP/IP supported control systems via open API: AMX[®], Crestron[®], KNX[®], RTI[®], Savant, URC[®], Leviton[®] etc.



SPECIFICATIONS

- » Input: HDMI Connector, Type A, 19 Pin Female
- » Output (Each): HDMI Connector, Type A, 19 Pin Female
- » Bandwidth: TMDS bandwidth 18 Gb/s
- » DDC Signal (Data): Input DDC Signal - 5 Volts p-p (TTL)
- » HDMI Video/Audio Signal: Input Video Signal - 1.2 Volts p-p
- » Power Supply: KD-PS5V2ASC, 5V/2A, 100-240VAC, 50-60Hz, Interchangeable head, screw-in connector
- » Regulation: CE, RoHS, WEEE, EAC
- » Enclosure: Black Metal
- » Product Dimensions: 8.25" x 4.0" x 1.7"
- » Packaging Dimensions: 10.75" x 8.9" x 2.2"
- » Product Weight: 0.9 lb
- » Shipping Weight: 2 lb

SYSTEM DESIGN EXAMPLE

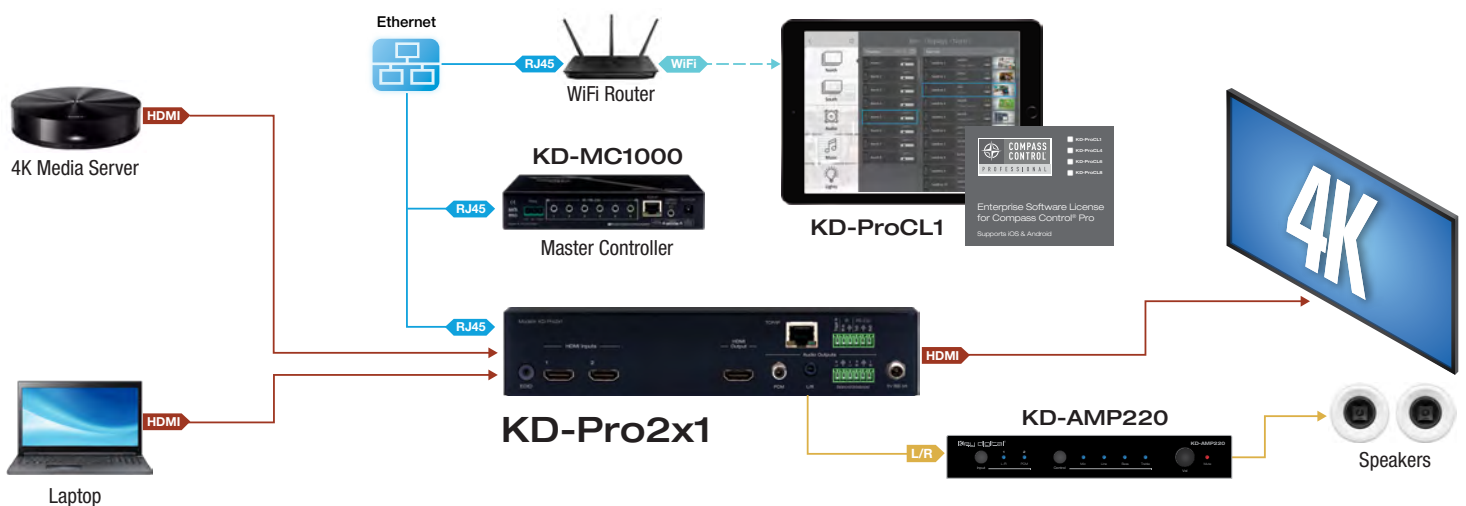

KD-Pro4x1

4x1 4K/18G HDMI Switcher with Audio De-embedding of Analog L/R Balanced/Unbalanced & Digital Coaxial Audio

KEY FEATURES

- › **HDMI Switching:** 4 HDMI sources to 1 HDMI output
- › **4K Support:** 4096x2160 or 3840x2160 30Hz at 4:4:4 and 60Hz at 4:4:4
- › **18 Gbps Bandwidth:** High Speed / Performance for latest HDMI standards
- › **HDR10 (High Dynamic Range):** More life-like images through a greater range of luminance levels
- › **HDCP 2.2 and HDMI Licensing:** Fully licensed and compatible with HDCP 2.2 and HDMI latest technologies
- › **Deep Color Support:** Up to UHD/4K 30Hz 4:4:4/12 bits or 60Hz 4:4:4/8 bit
- › **Audio De-Embedding:** Audio from the selected HDMI input is de-embedded through the Coax digital (PCM) or Analog L/R Balanced/Unbalanced
- › **Full Buffer System™:** Manages TMDS re-clocking / signal re-generation, HDCP authentication to source & display, and EDID Control handshake
- › **EDID:** Internal library with 15 default EDID handshakes for inputs, in addition to native EDID data for Output/Display
- › **TMDS re-clocking:** Support for long HDMI connectivity using Key Digital® HDMI cables
- › **Lossless Compressed Digital Audio:** Dolby® TrueHD, Dolby® Digital Plus, DTS-HD Master Audio™, and Dolby® Atmos
- › **Control:** Front panel buttons/LEDs, Trigger In, Serial IR, Optical IR, RS-232 Control, and TCP/IP Control
- › **Control System Support:** Key Digital® App ready. Compass Control® Pro ready. Fully controllable by all IR, RS-232, and TCP/IP supported control systems via open API: AMX®, Crestron®, Control4®, KNX®, RTI®, Savant, URC®, Leviton® etc.



SPECIFICATIONS

- › Input: HDMI Connector, Type A, 19 Pin Female
- › Output (Each): HDMI Connector, Type A, 19 Pin Female
- › Bandwidth: TMDS bandwidth 18 Gb/s
- › DDC Signal (Data): Input DDC Signal - 5 Volts p-p (TTL)
- › HDMI Video/Audio Signal: Input Video Signal - 1.2 Volts p-p
- › Power Supply: KD-PS5V2ASC, 5V/2A, 100-240VAC, 50-60Hz, Interchangeable head, screw-in connector
- › Regulation: CE, RoHS, WEEE, EAC
- › Enclosure: Black Metal
- › Product Dimensions: 8.25" x 4.0" x 1.7"
- › Packaging Dimensions: 10.75" x 8.9" x 2.2"
- › Product Weight: 0.9 lb
- › Shipping Weight: 2 lb

SYSTEM DESIGN EXAMPLE

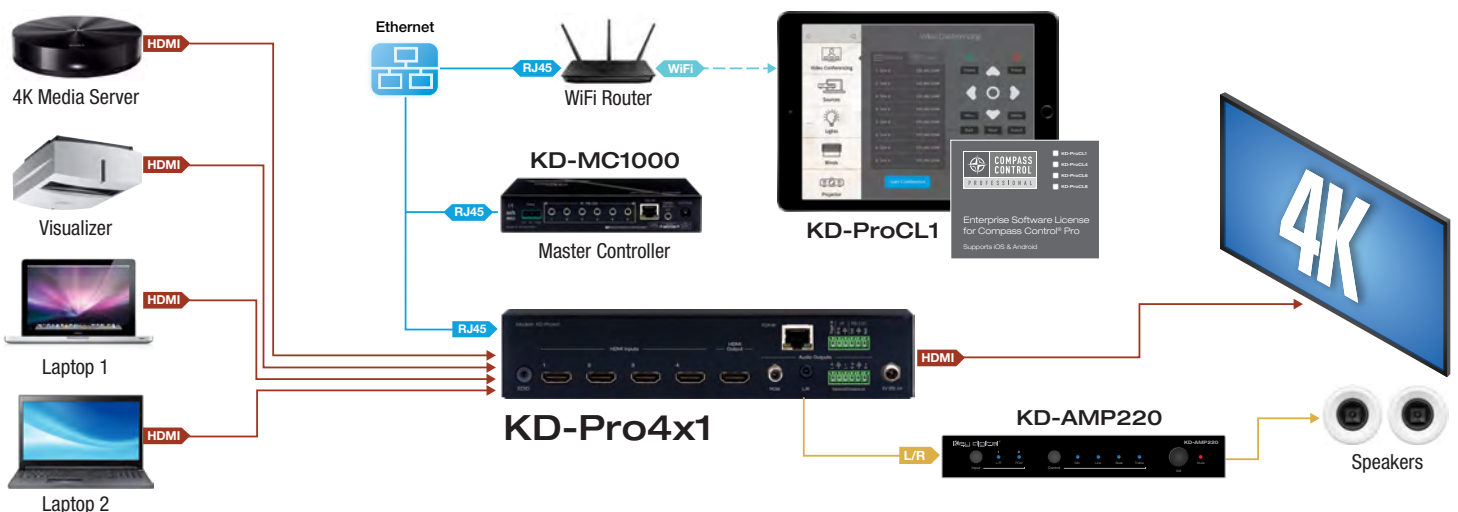

HDMI Switchers

KD-S2x1X

2x1 (4K@60Hz/18G/444) HDMI Switcher with L/R / Optical Audio & De-Embedded Audio Output

KEY FEATURES

- › **HDMI Switching:** 2 HDMI sources to 1 HDMI output/display
- › **Ultra HD/4K Support:** 4096x2160 or 3840x2160 24/25/30/60Hz at 4:4:4 (signals up to 18Gbps bandwidth)
- › **HDCP Licensing:** Fully licensed and compatible with HDCP 2.2
- › **HDR10 (High Dynamic Range):** More life-like images through a greater range of luminance levels
- › **Resolution Support:** Supports all SD, HD, and VESA (VGA, SVGA, XGA, WXGA, SXGA, UXGA) up to 4096x2160p.
- › **Deep Color Support:** Up to UHD/4K 30Hz 4:4:4/12 bits or 60Hz 4:4:4/8 bit
- › **Audio De-embedding:** Audio of the selected HDMI input is output at the digital optical and analog 3.5mm stereo connectors
- › **Auto-Sensing:** Automatic selection of newly detected source and switching from newly disconnected source via hot plug detection voltage when enabled
- › **Full Buffer System™:** Manages TMDS re-clocking / signal re-generation, HDCP authentication to source & display, and EDID Control handshake
- › **EDID Management:** Internal library with 15 internal EDID handshakes including 4K with HDR in addition to native EDID data copied from the output/display
- › **Lossless Compressed Digital Audio:** Dolby® TrueHD, Dolby® Digital Plus, DTS-HD Master Audio™, and Dolby® Atmos
- › **CEC Pass-thru:** From connected display to selected HDMI source
- › **Control:** Front panel buttons/LEDs, Optical IR
- › **Control System Support:** Compass Control® Pro ready. Fully controllable by all IR supported control systems



SPECIFICATIONS

- › Input (Each): HDMI Connector, Type A, 19 Pin Female
- › Output: HDMI Connector, Type A, 19 Pin Female
- › Bandwidth: TMDS bandwidth 18 Gbps
- › DDC Signal (Data): Input DDC Signal - 5 Volts p-p (TTL)
- › HDMI Video/Audio Signal: Input Video Signal - 1.2 Volts p-p
- › Power Supply: KD-PS5V1ASC, 5V/1A, 100-240VAC, 50-60Hz, Interchangeable head, screw-in connector
- › Regulation: CE, RoHS, WEEE, EAC
- › Enclosure: Black Metal
- › Product Dimensions: 4.3" x 1.1" x 2.8"
- › Packaging Dimensions: 6.3" x 4.2" x 3.7"
- › Product Weight: 0.5 lb; 0.9 lb
- › Shipping Weight: 0.7 lb; 1.5 lb

SYSTEM DESIGN EXAMPLE



HDMI Switchers

KD-S4x1X

4x1 (4K@60Hz/18G/444) HDMI Switcher with L/R / Optical Audio & De-Embedded Audio Output

KEY FEATURES

- **HDMI Switching:** 4 HDMI sources to 1 HDMI output/display
- **Ultra HD/4K Support:** 4096x2160 or 3840x2160 24/25/30/60hz at 4:4:4 (signals up to 18Gbps bandwidth)
- **HDCP Licensing:** Fully licensed and compatible with HDCP 2.2
- **HDR10 (High Dynamic Range):** More life-like images through a greater range of luminance levels
- **Resolution Support:** Supports all SD, HD, and VESA (VGA, SVGA, XGA, WXGA, SXGA, UXGA) up to 4096x2160p
- **Deep Color Support:** Up to UHD/4K 30Hz 4:4:4/12 bits or 60Hz 4:4:4/8 bit
- **Audio De-embedding:** Audio of the selected HDMI input is output at the digital optical and analog 3.5mm stereo connectors
- **Auto-Sensing:** Automatic selection of newly detected source and switching from newly disconnected source via hot plug detection voltage when enabled
- **Full Buffer System™:** Manages TMDS re-clocking / signal re-generation, HDCP authentication to source & display, and EDID Control handshake
- **EDID Management:** Internal library with 15 internal EDID handshakes including 4K with HDR in addition to native EDID data copied from the output/display
- **Lossless Compressed Digital Audio:** Dolby® TrueHD, Dolby® Digital Plus, DTS-HD Master Audio™, and Dolby® Atmos
- **CEC Pass-thru:** From connected display to selected HDMI source
- **Control:** Front panel buttons/LEDs, Optical IR
- **Control System Support:** Compass Control® Pro ready. Fully controllable by all IR supported control systems



SPECIFICATIONS

- Input (Each): HDMI Connector, Type A, 19 Pin Female
- Output: HDMI Connector, Type A, 19 Pin Female
- Bandwidth: TMDS bandwidth 18 Gbps
- DDC Signal (Data): Input DDC Signal - 5 Volts p-p (TTL)
- HDMI Video/Audio Signal: Input Video Signal - 1.2 Volts p-p
- Power Supply: KD-PS5V1ASC, 5V/1A, 100-240VAC, 50-60Hz, Interchangeable head, screw-in connector
- Regulation: CE, RoHS, WEEE, EAC
- Enclosure: Black Metal
- Product Dimensions: 6.25" x 1.1" x 3.1"
- Packaging Dimensions: 9.8" x 4.5" x 3.35"
- Product Weight: 0.9 lb
- Shipping Weight: 1.5 lb

SYSTEM DESIGN EXAMPLE



HDMI Switchers

KD-S2x1

2x1 4K/18G HDMI Switcher

KEY FEATURES

- › **Digital Switching:** 2 HDMI Sources to 1 HDMI Display
- › **4K Support:** 4096x2160 or 3840x2160 30Hz at 4:4:4 and 60Hz at 4:4:4
- › **18 Gbps Bandwidth:** High Speed / Performance for latest HDMI standards
- › **HDR10 (High Dynamic Range):** More life-like images through a greater range of luminance levels
- › **HDCP 2.2 and HDMI Licensing:** Fully licensed and compatible with HDCP 2.2 and HDMI latest technologies
- › **EDID Control:** Internal library with 16 default EDID configurations for each input, including native EDID data of Output/Display
- › **Full Buffer™ System:** Manages TMDS re-clocking / signal re-generation, HDCP source & display authentication, Hot Plug Management and EDID Control handshake
- › **Lossless Compressed Digital Audio:** Dolby® TrueHD, Dolby® Digital Plus, Dolby® Atmos and DTS-HD Master Audio™
- › **Deep Color Support:** Up to 12 Bit at UHD/4K 24/25/30Hz 4:4:4
- › **I2C Communication:** EDID and HDCP buffering from Display to Source
- › **Control:** Front panel push buttons and LEDs, Optical IR
- › **CEC:** Full Support
- › **Control System Support:** Fully controllable by all IR supported control systems via open API: Compass Control® Pro, AMX®, Crestron®, KNX®, RTI®, Savant, URC®, Leviton® etc.



SPECIFICATIONS

- › Input: HDMI Connector, Type A, 19 Pin Female
- › Output (Each): HDMI Connector, Type A, 19 Pin Female
- › Bandwidth: TMDS bandwidth 18 Gb/s
- › DDC Signal (Data): Input DDC Signal - 5 Volts p-p (TTL)
- › HDMI Video/Audio Signal: Input Video Signal - 1.2 Volts p-p
- › Power Supply: KD-PS5V1ASC, 5V/1A, 100-240VAC, 50-60Hz, Interchangeable head, screw-in connector
- › Regulation: CE, RoHS, WEEE, EAC
- › Enclosure: Black Metal
- › Product Dimensions: 4.3" x 1.1" x 2.8"
- › Packaging Dimensions: 6.3" x 4.2" x 3.7"
- › Product Weight: 0.5 lb
- › Shipping Weight: 0.7 lb

SYSTEM DESIGN EXAMPLE



HDMI Switchers

KD-S4x1

4x1 4K/18G HDMI Switcher

KEY FEATURES

- › **Digital Switching:** 4 HDMI Sources to 1 HDMI Display
- › **4K Support:** 4096x2160 or 3840x2160 30Hz at 4:4:4 and 60Hz at 4:4:4
- › **18 Gbps Bandwidth:** High Speed / Performance for latest HDMI standards
- › **HDR10 (High Dynamic Range):** More life-like images through a greater range of luminance levels
- › **HDCP 2.2 and HDMI Licensing:** Fully licensed and compatible with HDCP 2.2 and HDMI latest technologies
- › **EDID Control:** Internal library with 16 default EDID configurations for each input, including native EDID data of Output/Display
- › **Full Buffer™ System:** Manages TMDS re-clocking / signal re-generation, HDCP source & display authentication, Hot Plug Management and EDID Control handshake
- › **Lossless Compressed Digital Audio:** Dolby® TrueHD, Dolby® Digital Plus, Dolby® Atmos and DTS-HD Master Audio™
- › **Deep Color Support:** Up to 12 Bit at UHD/4K 24/25/30Hz 4:4:4
- › **I2C Communication:** EDID and HDCP buffering from Display to Source
- › **Control:** Front panel push buttons and LEDs, Optical IR
- › **CEC:** Full Support
- › **Control System Support:** Fully controllable by all IR supported control systems via open API: Compass Control® Pro, AMX®, Crestron®, KNX®, RTI®, Savant, URC®, Leviton® etc.

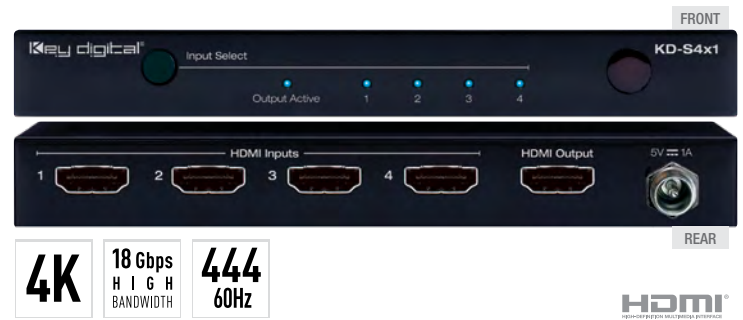

SPECIFICATIONS

- › Input: HDMI Connector, Type A, 19 Pin Female
- › Output (Each): HDMI Connector, Type A, 19 Pin Female
- › Bandwidth: TMDS bandwidth 18 Gb/s
- › DDC Signal (Data): Input DDC Signal - 5 Volts p-p (TTL)
- › HDMI Video/Audio Signal: Input Video Signal - 1.2 Volts p-p
- › Power Supply: KD-PS5V1ASC, 5V/1A, 100-240VAC, 50-60Hz, Interchangeable head, screw-in connector
- › Regulation: CE, RoHS, WEEE, EAC
- › Enclosure: Black Metal
- › Product Dimensions: 6.25" x 1.1" x 3.1"
- › Packaging Dimensions: 9.8" x 4.5" x 3.35"
- › Product Weight: 0.9 lb
- › Shipping Weight: 1.5 lb

SYSTEM DESIGN EXAMPLE



KD-DA2x4G

2x4 4K/18G POH/HDBT/HDMI Distribution Amplifier/Switcher with Audio De-Embedding
(Includes KIT 4 Rx 100 Meters Extenders)

KEY FEATURES

- › **HDMI Switching & Distribution:** 2 HDMI sources to 4 HDBaseT outputs
- › **Power over HDBaseT:** All included Rx units powered by the main unit
- › **Ultra HD/4K Support:** 4096x2160 or 3840x2160 24/25/30/60hz at 4:4:4 (signals up to 18Gbps bandwidth)
- › **Signal Extension:** For resolution and cable quality
 - › 4K/UHD: Up to 250 ft. (76m) using CAT5e/CAT6/CAT6A/CAT7
 - › 1080p: Up to 328 ft. (100m) maximum
- › **18 Gbps Bandwidth:** High Speed / Performance for latest HDMI standards
- › **High Dynamic Range (HDR) Format Support:** HDR10 and Dolby® Vision
- › **HDCP 2.2:** Compliancy up to HDCP 2.2 and backward compliant
- › **Resolution Support:** Supports all SD, HD, and VESA (VGA, SVGA, XGA, WXGA, SXGA, UXGA) up to 4096x2160p
- › **Deep Color Support:** Up to UHD/4K 60Hz 4:2:0/12 bits, 60Hz 4:2:2/12 bits
- › **Auto-Sensing:** Automatic selection of newly detected source and switching from newly disconnected source via hot plug detection voltage when enabled
- › **Audio De-embedder:** Audio of the selected HDMI input is de-embedded at the Coax digital (PCM) and Analog L/R balanced/unbalanced connectors
- › **Control Pass-Thru:** 4 three pin phoenix connectors for bi-directional IR or RS-232 for each HDBaseT output. 4 IR sensors and IR emitters included.
- › **Full Buffer System™:** Manages TMDS re-clocking / signal re-generation, HDCP authentication to source & display, and EDID Control handshake
- › **EDID:** Internal library with 15 internal EDID handshakes including 4K with HDR in addition to native EDID data copied from an Output/Display 1
- › **Lossless Compressed Digital Audio:** Dolby® TrueHD, Dolby® Digital Plus, DTS-HD Master Audio™, and Dolby® Atmos
- › **CEC Disconnect:** Prevents all device communication signals via CEC, ARC, and HDMI Ethernet channels

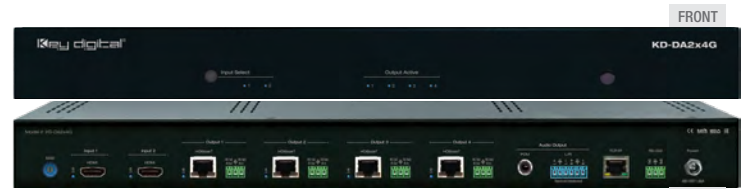

- › **Control:** Front panel buttons/LEDs, Serial IR, Optical IR, RS-232 Control, and TCP/IP Control
- › **Control System Support:** Key Digital® app ready. Key Digital Management Software™ Pro (KDMS™ Pro) ready, Compass Control® Pro ready. Fully controllable by all IR, RS-232, and TCP/IP supported control systems via open API.
- › **Key Digital® App & KDMS® Pro Ready:** Scan & detect population for pre-built GUI and TCP/IP control via Key Digital® iOS App and Key Digital Management Software™ Pro (KDMS™ Pro) PC Software

SPECIFICATIONS

- › Power: +48V/1.66A, 80W
- › Regulation: CE, RoHS, WEEE, EAC, EAC
- › Rack Mount: 1U, 1 Rack Width (rack ears included)
- › Enclosure: Black Metal
- › Product Dimensions: 17.3 x 5.25 x 1.72" (440 x 133.5 x 43.8 mm)
- › Shipping Carton Dimensions: 20 x 10 x 5.7" (510 x 255 x 145 mm)
- › Product Weight: 6 lb
- › Shipping Weight: 9 lb
- › Accessories: IR Remote, UL Certified Power Supply

SYSTEM DESIGN EXAMPLE

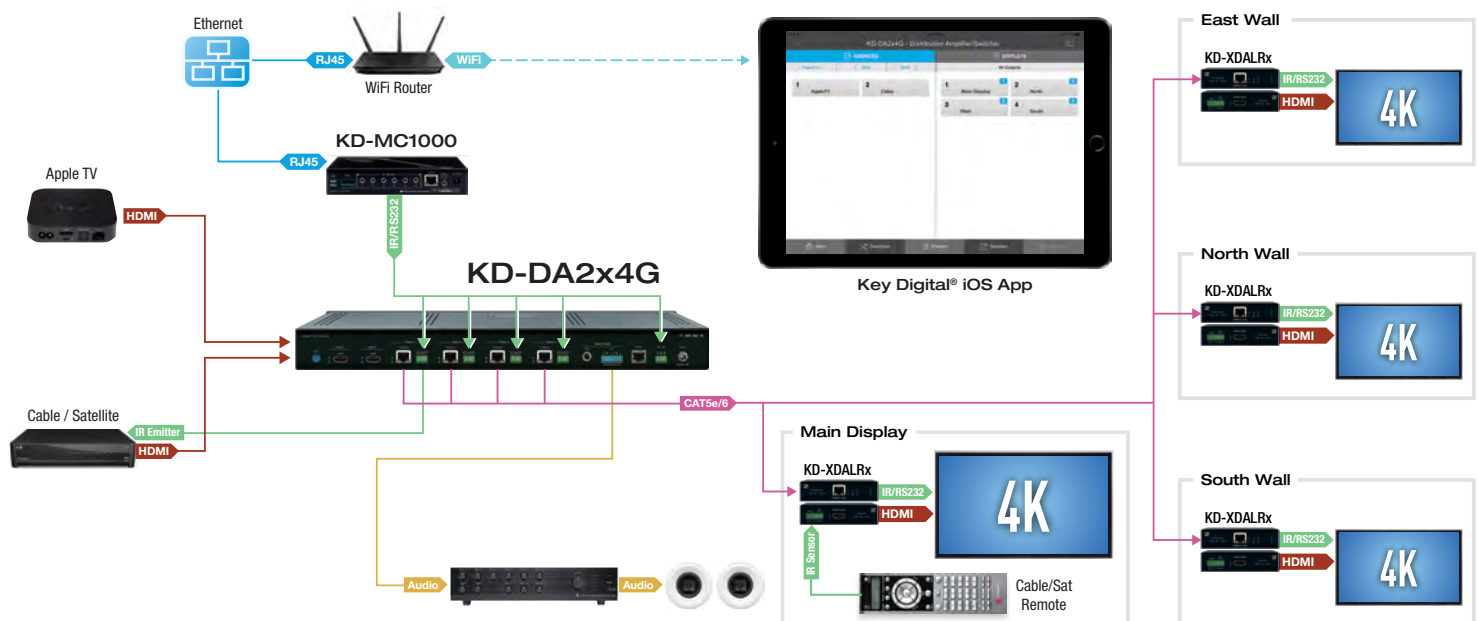

KD-DA2x8G

2x8 4K/18G POH/HDBT/HDMI Distribution Amplifier/Switcher with Audio De-Embedding
(Includes KIT 8 Rx 100 Meters Extenders)

KEY FEATURES

- › **HDMI Switching & Distribution:** 2 HDMI sources to 8 HDBaseT outputs
- › **Power over HDBaseT:** All included Rx units powered by the main unit
- › **Ultra HD/4K Support:** 4096x2160 or 3840x2160 24/25/30/60hz at 4:4:4 (signals up to 18Gbps bandwidth)
- › **Signal Extension:** For resolution and cable quality
 - › 4K/UHD: Up to 250 ft. (76m) using CAT5e/CAT6/CAT6A/CAT7
 - › 1080p: Up to 328 ft. (100m) maximum
- › **18 Gbps Bandwidth:** High Speed / Performance for latest HDMI standards
- › **High Dynamic Range (HDR) Format Support:** HDR10 and Dolby® Vision
- › **HDCP 2.2:** Compliancy up to HDCP 2.2 and backward compliant
- › **Resolution Support:** Supports all SD, HD, and VESA (VGA, SVGA, XGA, WXGA, SXGA, UXGA) up to 4096x2160p
- › **Deep Color Support:** Up to UHD/4K 60Hz 4:2:0/12 bits, 60Hz 4:2:2/12 bits
- › **Auto-Sensing:** Automatic selection of newly detected source and switching from newly disconnected source via hot plug detection voltage when enabled
- › **Audio De-embedder:** Audio of the selected HDMI input is de-embedded at the Coax digital (PCM) and Analog L/R balanced/unbalanced connectors
- › **Control Pass-Thru:** 8 three pin phoenix connectors for bi-directional IR or RS-232 for each HDBaseT output. 8 IR sensors and IR emitters included.
- › **Full Buffer System™:** Manages TMDS re-clocking / signal re-generation, HDCP authentication to source & display, and EDID Control handshake
- › **EDID:** Internal library with 15 internal EDID handshakes including 4K with HDR in addition to native EDID data copied from an Output/Display 1
- › **Lossless Compressed Digital Audio:** Dolby® TrueHD, Dolby® Digital Plus, DTS-HD Master Audio™, and Dolby® Atmos
- › **CEC Disconnect:** Prevents all device communication signals via CEC, ARC, and HDMI Ethernet channels



- › **Control:** Front panel buttons/LEDs, Serial IR, Optical IR, RS-232 Control, and TCP/IP Control
- › **Control System Support:** Key Digital® app ready. Key Digital Management Software™ Pro (KDMS™ Pro) ready, Compass Control® Pro ready. Fully controllable by all IR, RS-232, and TCP/IP supported control systems via open API.
- › **Key Digital® App & KDMS® Pro Ready:** Scan & detect population for pre-built GUI and TCP/IP control via Key Digital® iOS App and Key Digital Management Software™ Pro (KDMS™ Pro) PC Software

SPECIFICATIONS

- › Power: +48V/1.66A, 80W
- › Regulation: CE, RoHS, WEEE, EAC, EAC
- › Rack Mount: 1U, 1 Rack Width (rack ears included)
- › Enclosure: Black Metal
- › Product Dimensions: 17.3 x 5.25 x 1.72" (440 x 133.5 x 43.8 mm)
- › Shipping Carton Dimensions: 20 x 10 x 5.7" (510 x 255 x 145 mm)
- › Product Weight: 6 lb
- › Shipping Weight: 9 lb
- › Accessories: IR Remote, UL Certified Power Supply

SYSTEM DESIGN EXAMPLE

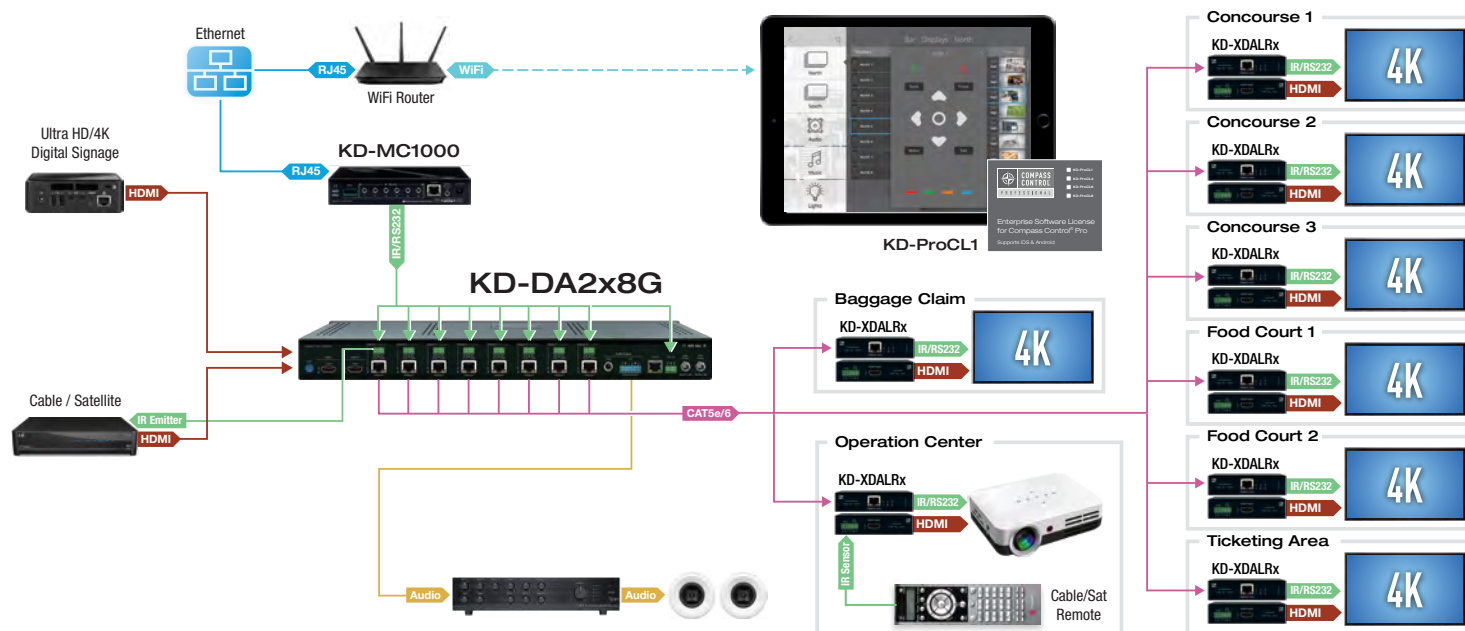



KD-DA1x2X

1x2 (4K@60Hz/18G/444) HDMI Distribution Amplifier with L/R / Optical Audio & De-Embedded Audio Output

KEY FEATURES

- › **HDMI Signal Distribution:** 1 HDMI source to 2 HDMI outputs/displays
- › **Ultra HD/4K Support:** 4096x2160 or 3840x2160 24/25/30/60hz at 4:4:4 (signals up to 18Gbps bandwidth)
- › **HDCP Licensing:** Fully licensed and compatible with HDCP 2.2
- › **HDR10 (High Dynamic Range):** More life-like images through a greater range of luminance levels
- › **Resolution Support:** Supports all SD, HD, and VESA (VGA, SVGA, XGA, WXGA, SXGA, UXGA) up to 4096x2160p.
- › **Deep Color Support:** Up to UHD/4K 30Hz 4:4:4/12 bits or 60Hz 4:4:4/8 bit
- › **Audio De-embedding:** Audio of the selected HDMI input is output at the digital Optical and analog 3.5mm stereo connectors.
- › **Full Buffer System™:** Manages TMDS re-clocking / signal re-generation, HDCP authentication to source & display, and EDID Control handshake
- › **EDID Management:** Internal library with 15 internal EDID handshakes including 4K with HDR in addition to native EDID data copied from the output/display 1
- › **Lossless Compressed Digital Audio:** Dolby® TrueHD, Dolby® Digital Plus, DTS-HD Master Audio™, and Dolby® Atmos
- › **CEC Disconnect:** Prevents unwanted control of source



SPECIFICATIONS

- › Input (Each): HDMI Connector, Type A, 19 Pin Female
- › Output: HDMI Connector, Type A, 19 Pin Female
- › Bandwidth: TMDS bandwidth 18 Gbps
- › DDC Signal (Data): Input DDC Signal - 5 Volts p-p (TTL)
- › HDMI Video/Audio Signal: Input Video Signal - 1.2 Volts p-p
- › Power Supply: KD-PS5V2ASC, 5V/2A, 100-240VAC, 50-60Hz, Interchangeable head, screw-in connector
- › Regulation: CE, RoHS, WEEE, EAC
- › Enclosure: Black Metal
- › Product Dimensions: 4.3" x 1.1" x 2.8"
- › Packaging Dimensions: 6.3" x 4.2" x 3.7"
- › Product Weight: 0.5 lb
- › Shipping Weight: 0.7 lb

SYSTEM DESIGN EXAMPLE

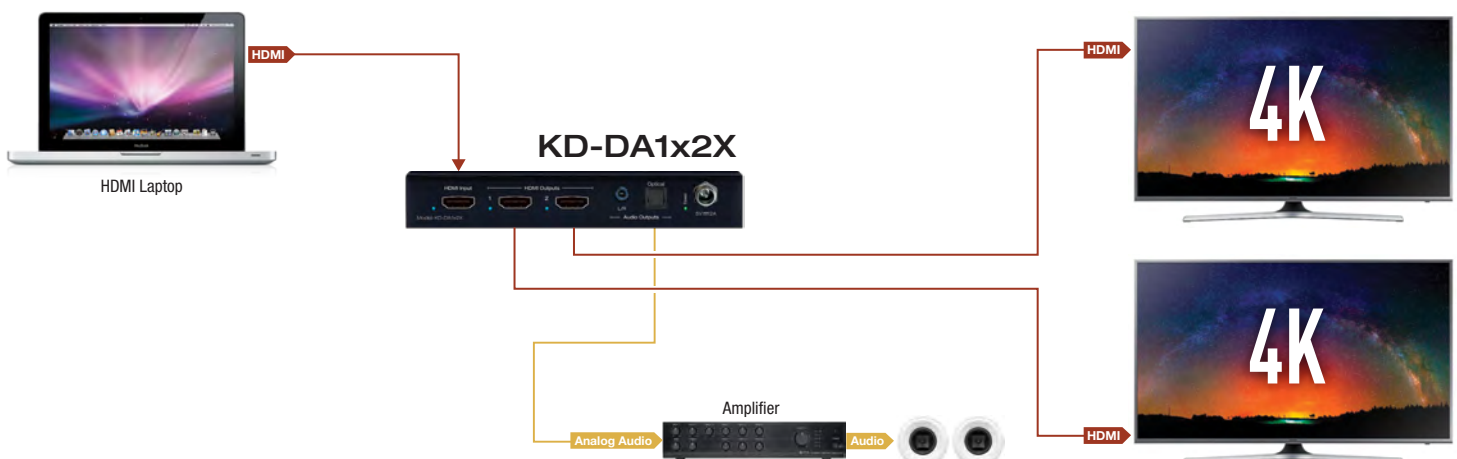



KD-DA1x4X

1x4 (4K@60Hz/18G/444) HDMI Distribution Amplifier with L/R / Optical Audio & De-Embedded Audio Output

KEY FEATURES

- › **HDMI Signal Distribution:** 1 HDMI source to 4 HDMI outputs/displays
- › **Ultra HD/4K Support:** 4096x2160 or 3840x2160 24/25/30/60hz at 4:4:4 (signals up to 18Gbps bandwidth)
- › **HDCP Licensing:** Fully licensed and compatible with HDCP 2.2
- › **HDR10 (High Dynamic Range):** More life-like images through a greater range of luminance levels
- › **Resolution Support:** Supports all SD, HD, and VESA (VGA, SVGA, XGA, WXGA, SXGA, UXGA) up to 4096x2160p.
- › **Deep Color Support:** Up to UHD/4K 30Hz 4:4:4/12 bits or 60Hz 4:4:4/8 bit
- › **Audio De-embedding:** Audio of the selected HDMI input is output at the digital Optical and analog 3.5mm stereo connectors.
- › **Full Buffer System™:** Manages TMDS re-clocking / signal re-generation, HDCP authentication to source & display, and EDID Control handshake
- › **EDID Management:** Internal library with 15 internal EDID handshakes including 4K with HDR in addition to native EDID data copied from the output/display 1
- › **Lossless Compressed Digital Audio:** Dolby® TrueHD, Dolby® Digital Plus, DTS-HD Master Audio™, and Dolby® Atmos
- › **CEC Disconnect:** Prevents unwanted control of source



SPECIFICATIONS

- › Input: HDMI Connector, Type A, 19 Pin Female
- › Output (Each): HDMI Connector, Type A, 19 Pin Female
- › Bandwidth: TMDS bandwidth 18 Gbps
- › DDC Signal (Data): Input DDC Signal - 5 Volts p-p (TTL)
- › HDMI Video/Audio Signal: Input Video Signal - 1.2 Volts p-p
- › Power Supply: KD-PS5V2ASC, 5V/2A, 100-240VAC, 50-60Hz, Interchangeable head, screw-in connector
- › Regulation: CE, RoHS, WEEE, EAC
- › Enclosure: Black Metal
- › Product Dimensions: 6.25" x 1.1" x 3.1"
- › Packaging Dimensions: 9.8" x 4.5" x 3.35"
- › Product Weight: 0.9 lb
- › Shipping Weight: 1.5 lb

SYSTEM DESIGN EXAMPLE

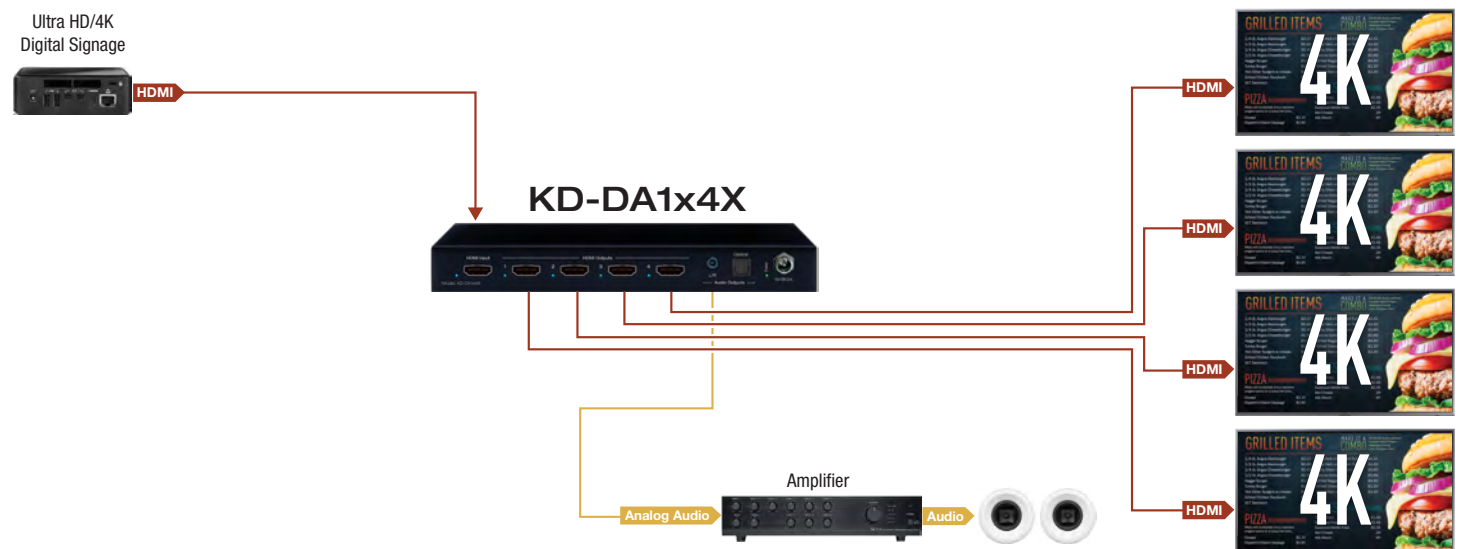

HDMI Distribution Amplifiers

KD-DA1x2

1x2 4K/18G HDMI Distribution Amplifier

KEY FEATURES

- › **Digital Distribution:** 1 HDMI Source to 2 HDMI Displays
- › **4K Support:** 4096x2160 or 3840x2160 30Hz at 4:4:4 and 60Hz at 4:4:4
- › **18 Gbps Bandwidth:** High Speed / Performance for latest HDMI standards
- › **HDR10 (High Dynamic Range):** More life-like images through a greater range of luminance levels
- › **HDCP 2.2 and HDMI Licensing:** Fully licensed and compatible with HDCP 2.2 and HDMI latest technologies
- › **Deep Color Support:** Up to UHD/4K 30Hz 4:4:4/12 bits or 60Hz 4:4:4/8 bit
- › **EDID Control:** Internal library with 15 EDID handshakes in addition to native EDID data of output/display 1
- › **Full Buffer™ System:** Manages TMDS re-clocking / signal re-generation, HDCP source & display authentication, Hot Plug Management and EDID Control handshake
- › **Lossless Compressed Digital Audio:** Dolby® TrueHD, Dolby® Digital Plus, DTS-HD Master Audio™ and Dolby® Atmos
- › **I2C Communication:** EDID and HDCP buffering from Display to Source
- › **CEC Disconnect:** Prevents all device communication signals via CEC, ARC, and HDMI Ethernet channels

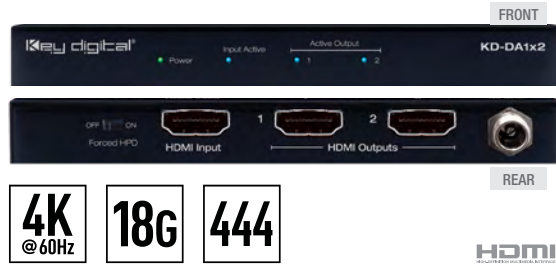

SPECIFICATIONS

- › Input: HDMI Connector, Type A, 19 Pin Female
- › Output (Each): HDMI Connector, Type A, 19 Pin Female
- › Power Supply: KD-PS5V1ASC, 5V/1A, 100-240VAC, 50-60Hz, Interchangeable head, screw-type connector
- › Regulation: CE, RoHS, WEEE, EAC
- › Rack Mount: 1U, Full Rack Width (rack ears included)
- › Enclosure: Black Metal
- › Product Dimensions: 4.9" x 2.5" x .55"
- › Shipping Dimensions: 6.5" x 4.3" x 3.4"
- › Product Weight: 0.5 lb.
- › Shipping Weight: 0.9 lb.

SYSTEM DESIGN EXAMPLE



HDMI Distribution Amplifiers

KD-DA1x4

1x4 4K/18G HDMI Distribution Amplifier

KEY FEATURES

- » **Digital Distribution:** 1 HDMI Source to 4 HDMI Displays
- » **4K Support:** 4096x2160 or 3840x2160 30Hz at 4:4:4 and 60Hz at 4:4:4
- » **18 Gbps Bandwidth:** High Speed / Performance for latest HDMI standards
- » **HDR10 (High Dynamic Range):** More life-like images through a greater range of luminance levels
- » **HDCP 2.2 and HDMI Licensing:** Fully licensed and compatible with HDCP 2.2 and HDMI latest technologies
- » **Deep Color Support:** Up to UHD/4K 30Hz 4:4:4/12 bits or 60Hz 4:4:4/8 bit
- » **EDID Control:** Internal library with 15 EDID handshakes in addition to native EDID data of output/display 1
- » **Full Buffer™ System:** Manages TMDS re-clocking / signal re-generation, HDCP source & display authentication, Hot Plug Management and EDID Control handshake
- » **Lossless Compressed Digital Audio:** Dolby® TrueHD, Dolby® Digital Plus, DTS-HD Master Audio™ and Dolby® Atmos
- » **I2C Communication:** EDID and HDCP buffering from Display to Source
- » **CEC Disconnect:** Prevents all device communication signals via CEC, ARC, and HDMI Ethernet channels



SPECIFICATIONS

- » Input: HDMI Connector, Type A, 19 Pin Female
- » Output (Each): HDMI Connector, Type A, 19 Pin Female
- » Power Supply: KD-PS5V1ASC, 5V/1A, 100-240VAC, 50-60Hz, Interchangeable head, screw-type connector
- » Regulation: CE, RoHS, WEEE, EAC
- » Enclosure: Black Metal
- » Product Dimensions: 6.9" x 3.25" x 0.55"
- » Shipping Dimensions: 8.25" x 4.75" x 3.6"
- » Product Weight: 0.8 lb.
- » Shipping Weight: 1.4 lb.

SYSTEM DESIGN EXAMPLE

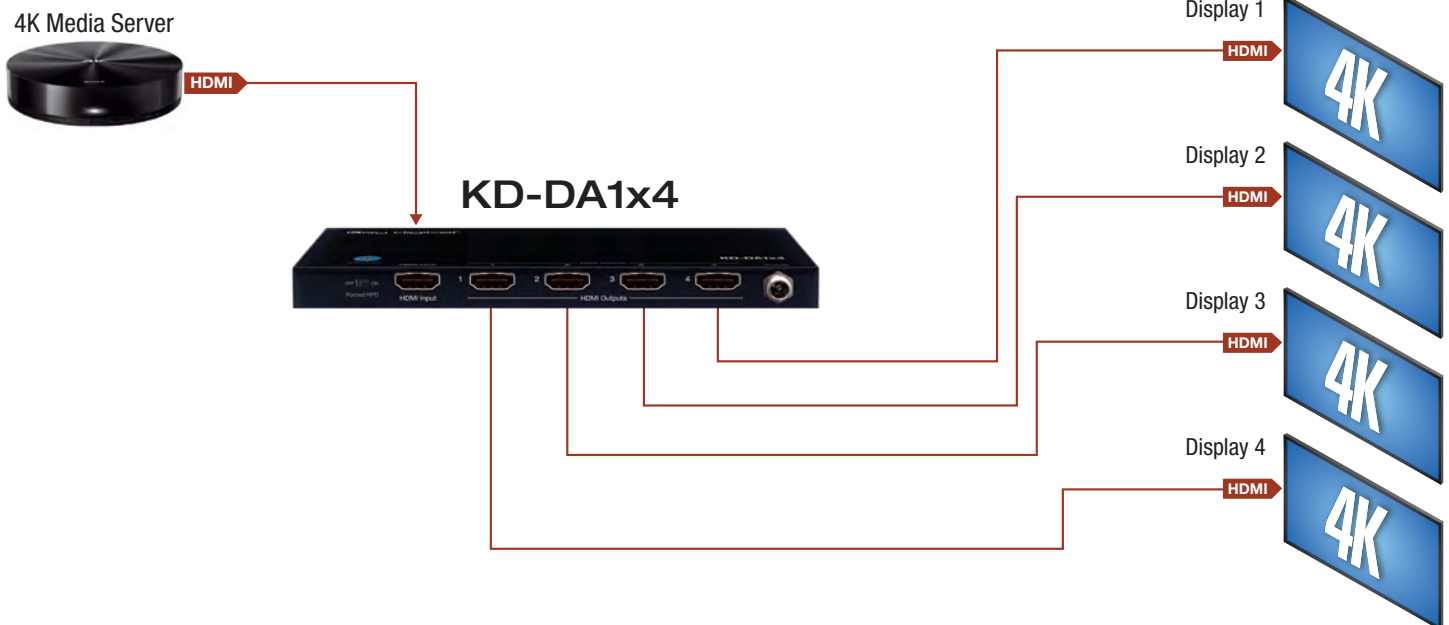

HDMI Distribution Amplifiers

KD-DA1x8

1x8 4K/18G HDMI Distribution Amplifier

KEY FEATURES

- › **Digital Distribution:** 1 HDMI Source to 8 HDMI Displays
- › **4K Support:** 4096x2160 or 3840x2160 30Hz at 4:4:4 and 60Hz at 4:4:4
- › **18 Gbps Bandwidth:** High Speed / Performance for latest HDMI standards
- › **HDR10 (High Dynamic Range):** More life-like images through a greater range of luminance levels
- › **HDCP 2.2 and HDMI Licensing:** Fully licensed and compatible with HDCP 2.2 and HDMI latest technologies
- › **Deep Color Support:** Up to UHD/4K 30Hz 4:4:4/12 bits or 60Hz 4:4:4/8 bit
- › **EDID Control:** Internal library with 15 EDID handshakes in addition to native EDID data of output/display 1
- › **Full Buffer™ System:** Manages TMDS re-clocking / signal re-generation, HDCP source & display authentication, Hot Plug Management and EDID Control handshake
- › **Lossless Compressed Digital Audio:** Dolby® TrueHD, Dolby® Digital Plus, DTS-HD Master Audio™ and Dolby® Atmos
- › **CEC Disconnect:** Prevents all device communication signals via CEC, ARC, and HDMI Ethernet channels



SPECIFICATIONS

- › Input: HDMI Connector, Type A, 19 Pin Female
- › Output (Each): HDMI Connector, Type A, 19 Pin Female
- › Power Supply: KD-PS5V4A, 5V/4A, 100-240VAC, 50-60Hz, Interchangeable head, screw-type connector
- › Regulation: CE, RoHS, WEEE, EAC
- › Enclosure: Black Metal
- › Product Dimensions: 10.75" x 4.01" x 0.67"
- › Shipping Dimensions: 15.7" x 5.3" x 2.28"
- › Product Weight: 1.5 lb.
- › Shipping Weight: 2.1 lb.

SYSTEM DESIGN EXAMPLE

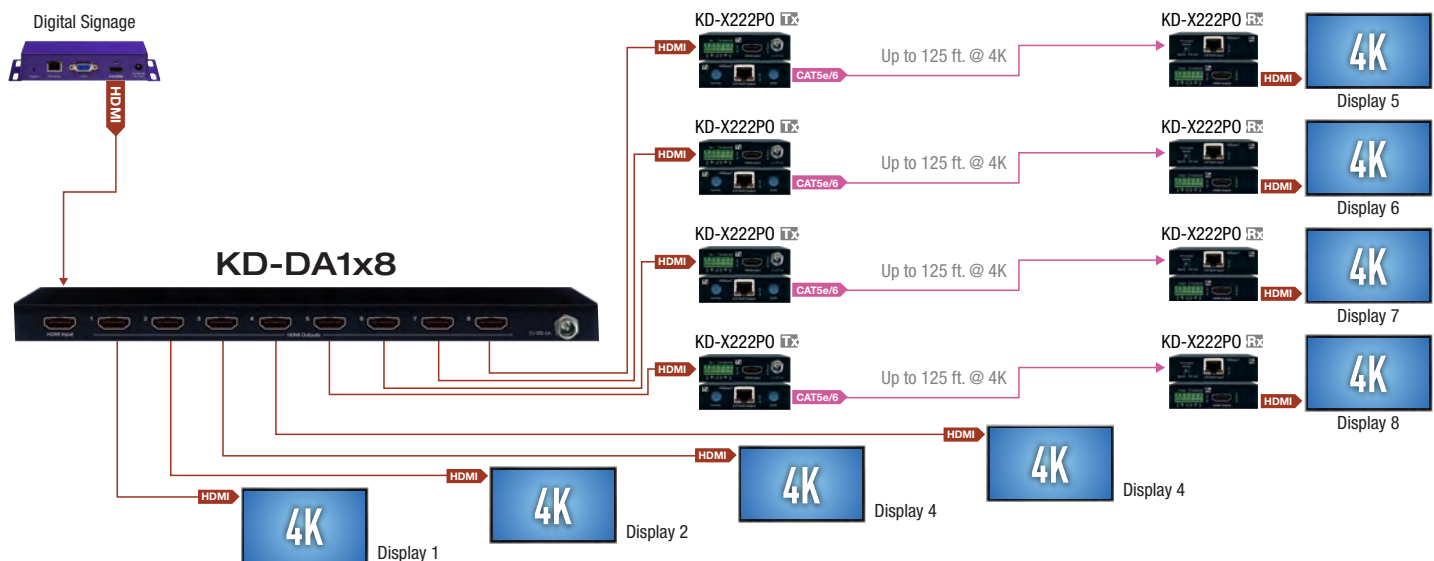

HDMI Fixers with Audio De-Embed

KD-FIX418A

HDMI Fixer (4K@60Hz/18G/444) with L/R / PCM Audio & De-Embedded Audio Output

KEY FEATURES

- **HDMI Correction:** Resolves common HDMI integration obstacles related to Hot Plug Detection, EDID handshaking, HDCP authentication, and bandwidth
- **Audio De-embedding:** HDMI input audio is de-embedded on an analog 3.5mm stereo and digital PCM connector.
- **18G Down-Convert:** Incoming 18Gbps bandwidth HDMI signals may be down-converted for integration with existing 10.2Gbps systems/infrastructure
- **Ultra HD/4K:** Supports up to 4096x2160 or 3840x2160 24/25/30/60hz at 4:4:4 (signals up to 18Gbps bandwidth)
- **HDCP Licensing:** Fully licensed and compatible with HDCP 2.2
- **HDR10 and Dolby Vision:** More life-like images through a greater range of luminance levels
- **Resolution Support:** Supports all SD, HD, and VESA (VGA, SVGA, XGA, WXGA, SXGA, UXGA) up to 4096x2160p.
- **Deep Color Support:** Up to UHD/4K 30Hz 4:4:4/12 bits or 60Hz 4:4:4/8 bit
- **Full Buffer System™:** Manages TMDS re-clocking / signal re-generation, HDCP authentication to source & display, Hot Plug management, and EDID control handshake
- **EDID Management:** Internal library with 15 internal EDID handshakes including 4K with HDR in addition to native EDID data copied from the output/display
- **Lossless Compressed Digital Audio:** Dolby® TrueHD, Dolby® Digital Plus, DTS-HD Master Audio™ and Dolby® Atmos
- **ARC Pass-thru:** From connected ARC supported display to connected ARC supported HDMI source



- **CEC Pass-thru:** From connected display to selected HDMI source
- **Control:** RS-232 control and connectivity status

SPECIFICATIONS

- » HDMI Input: HDMI Connector, Type A, 19 Pin Female
- » HDMI Output: HDMI Connector, Type A, 19 Pin Female
- » HDMI Bandwidth: TMDS bandwidth 18Gbps
- » Power Supply: KD-PS5V1ASC, 5V/1A, 100-240VAC, 50-60Hz, Interchangeable head, screw-in connector
- » Regulation: CE, RoHS, WEEE, EAC, EAC
- » Enclosure: Black metal
- » Power Supply: USB to micro USB cable (power adapter not included)
- » Product: 2.17" x 3.085" x 0.68", Weight: 4 oz
- » Packaging: 2.5" x 3.5" x 1", Weight: 6 oz

USAGE EXAMPLES

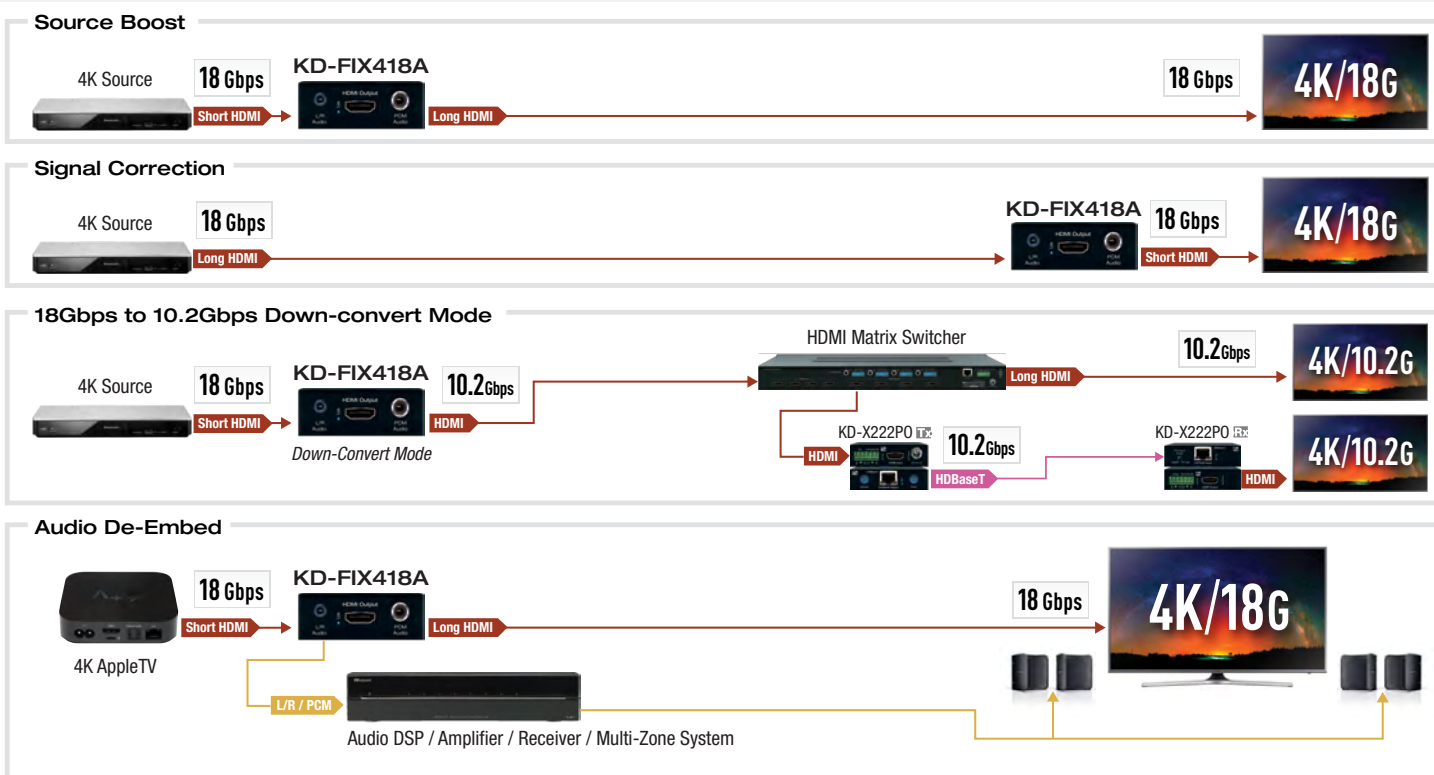

*Maximum one active/directional HDMI cable may be used for 18Gbps signals

KD-FIX418

4K/18G HDMI Fixer, Booster, Buffer of EDID, HDCP, Hot Plug, 18G to 10G Compress/Decompress

KEY FEATURES

- ▶ **HDMI Correction:** Resolves common HDMI integration obstacles related to HDCP, EDID, Hot Plug Detection, and bandwidth
- ▶ **Compression/Decompression:** Pair units to compress and decompress 18Gbps content with 10.2Gbps cabling
- ▶ **Input Boost Mode:** High equalization option on HDMI input for repair of degraded incoming signals
- ▶ **Cabling Extension:** Works with HDMI cabling for extension of 4K signals with HDR10 up to 75 ft / 23m in or out. Maximum one active/directional HDMI cable may be used for 18Gbps signal.
- ▶ **4K/UHD Support:** 4096x2160 or 3840x2160 24/25/30/60hz at 4:4:4 (up to 18Gbps bandwidth)
- ▶ **HDR10 and Dolby Vision:** More life-like images via a greater range of luminance levels
- ▶ **HDCP2.2:** Compliancy up to HDCP 2.2 and backward compliant
- ▶ **Deep Color Support:** Up to 4K/UHD 30Hz 4:4:4/12 bits or 60Hz 4:4:4/8 bit
- ▶ **Low Profile:** Super compact chassis size
- ▶ **USB Powered:** Low power consumption enables power from standard USB micro port
- ▶ **Full Buffer System™:** Manages TMDS re-clocking / signal re-generation, HDCP source & display authentication, Hot Plug Management and EDID Control handshake
- ▶ **Lossless Compressed Digital Audio:** Dolby® TrueHD, Dolby® Digital Plus, DTS-HD Master Audio™ and Dolby® Atmos



- ▶ **Auto-EQ:** Precise signal equalization applied to input and output signals automatically delivers best possible picture quality
- ▶ **EDID Control:** Internal library with 15 EDID handshakes including 4K with HDR in addition to native EDID data of output/display
- ▶ **Forced HPD:** Enables integrator to choose if active signal voltage is forced to connected input device
- ▶ **CEC and ARC Pass-thru:** Enables inter-device communication signals via CEC, ARC, and HDMI Ethernet channels

SPECIFICATIONS

- » Regulation: CE, RoHS, WEEE, EAC, EAC
- » Enclosure: Black metal
- » Power Supply: USB to micro USB cable (power adapter not included)
- » Product: 2.17" x 3.085" x 0.68", Weight: 4 oz
- » Packaging: 2.5" x 3.5" x 1", Weight: 6 oz

USAGE EXAMPLES

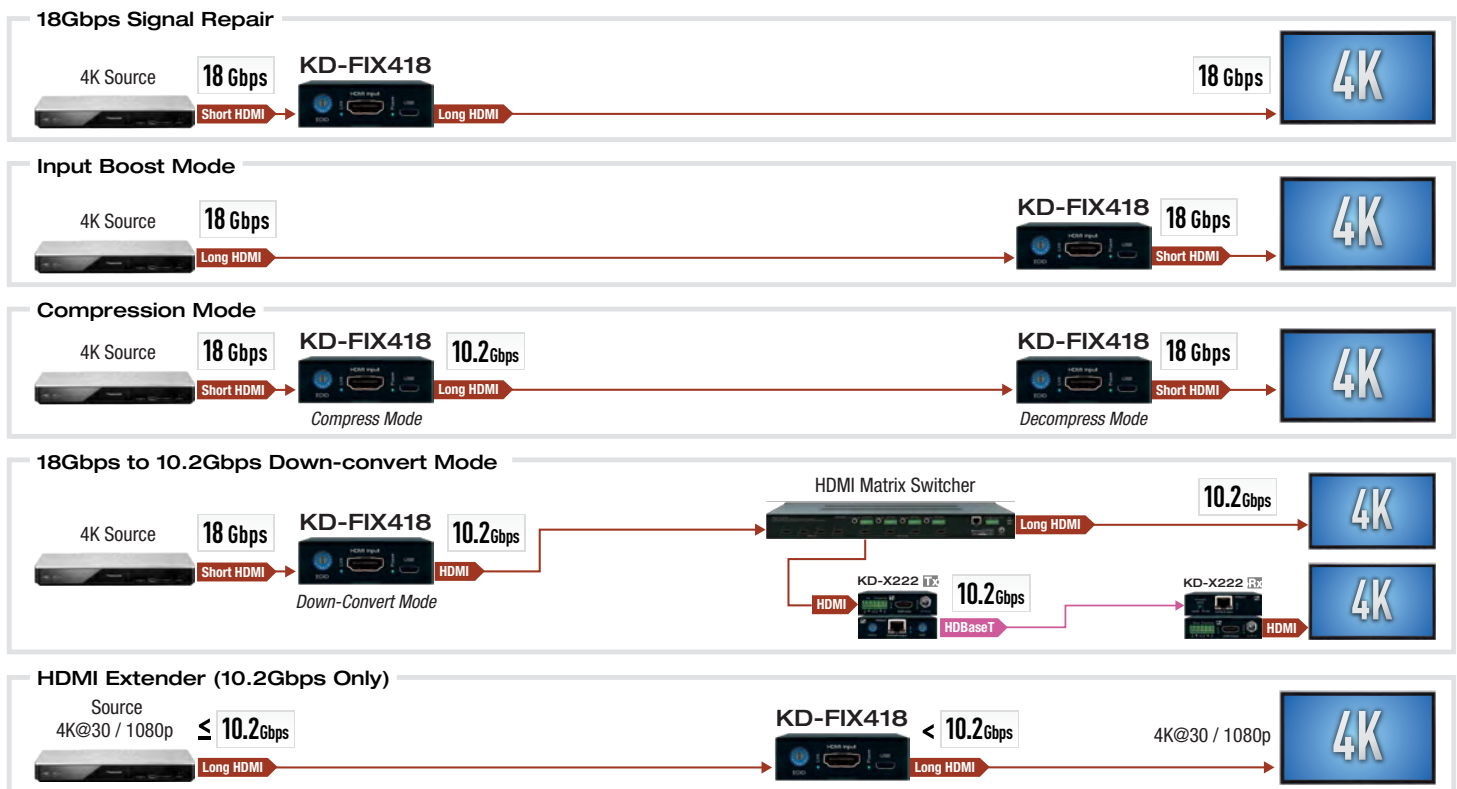

*Maximum one active/directional HDMI cable may be used for 18Gbps signals

HDMI Extenders, Boosters & Buffers

KD-HDFIX22

4K HDMI Extender, Booster & Buffer of EDID, TMDS, Hot Plug Control, Audio De-Embedding, HDR10, HDCP2.2

KEY FEATURES

- › **Extension:** Capable of extending UHD/4K and 1080p resolution up to 75 ft. / 23 m. in and 75 ft. / 23 m. out (150 ft. / 46 m. total)
- › **HDMI Correction:** Resolves common HDMI integration obstacles such as HDCP, EDID, HPD, and audio breakout
- › **Resolution Support:** Supports all SD, HD, and VESA resolutions up to Ultra HD/4K, 3D and 1080p/60 (60Hz & 50Hz)
- › **4K/Ultra HD:** 4096x2160 or 3840x2160 30Hz at 4:4:4 and 60Hz at 4:2:0
- › **HDR (High Dynamic Range):** More life-like images through a greater range of luminance levels
- › **HDCP 2.2:** Compliancy up to HDCP 2.2
- › **Full Buffer System™:** Manages TMDS re-clocking / signal re-generation, HDCP authentication to source & display, and EDID Control handshake
- › **Audio De-Embedding:** Audio from the HDMI input is de-embedded through the Coax digital (PCM) and/or Analog L/R audio output
- › **Auto-EQ:** Precise signal equalization applied to input and output signals automatically delivers best possible picture quality
- › **EDID Control:** 15 internal EDID tables or EDID copy from output/display
- › **Forced HPD:** Enables integrator to choose if active signal voltage is forced to connected input device
- › **HDMI and HDCP Licensing:** Fully licensing and compatible with HDCP 2.2 and HDMI latest technology such as 4K/UHD 4:2:0/8bit at 60f/s
- › **I2C Communication:** EDID and HDCP authentication to Display and Source
- › **RS-232 Controllable:** Control of unit and connectivity status
- › **CEC Support:** For inter-device control between main input and output HDMI channel
- › **Deep Color Support:** Up to 16 bits/color at 1080p/60



SPECIFICATIONS

- › HDMI Connector: Type A 19 Pin Female
- › Advanced HDMI features: Ultra HD/4K, 3D
- › Audio: Supports DTS-HD, Dolby True HD and 2 CH PCM
- › External Analog Audio: supports 2 Channel PCM audio only, NO Multi-Channel, PCM, Dolby, DTS or HD audio support
- › HDMI Video/Audio signal: 1.2V p-p
- › DDC Signal: 5V p-p (TTL)
- › Regulation: CE, RoHS, WEEE, EAC
- › Power Supply: KD-PS5V1A, 5V/1A, 100-240VAC, 50-60Hz, Interchangeable head
- › Product Dimensions: 3.6" x 2.5" x 1", Weight: 4 oz
- › Shipping Dimensions: 6.3" x 4.2" x 3.3", Weight: 16 oz
- › Enclosure: Black Metal

SYSTEM DESIGN EXAMPLE



HDMI/VGA Switcher/Scaler and HDBaseT Extender

KD-SX440WP

4K 2x1 HDMI/VGA Wall-Plate Switcher, Scaler & Extender with HDBT Output.
(Includes KIT Wall-Plate Tx/Rx 4K/70meters 1080P/100meters)

KEY FEATURES

- › **4K Support:** Supports signals up to 4096x2160 60Hz [4:2:0] 8bit, 4096x2160 30Hz [4:2:2] 12bit, and 4096x2160 30Hz [4:4:4] 8bit
- › **Presentation Switching:** 1 HDMI and 1 VGA + Audio source to 1 HDBaseT/HDMI output
- › **Auto Switching:** Newly connected source is discreetly selected
- › **Converts:** VGA video and analog audio to HDMI
- › **Video Scaling:** Processing of VGA signals ensures proper display
 - › Aspect ratio / Resolution adjust
 - › Image shift / stretch
- › **Signal Extension:** For resolution and cable quality
 - › **4K/UHD:** Up to 230 ft. (70m) using CAT5e/6
Up to 328 ft. (100m) using CAT6A STP / CAT7
 - › **1080p:** Up to 328 ft. (100m) maximum
- › **HDR10 (High Dynamic Range):** More life-like images through a greater range of luminance levels
- › **HDCP 2.2:** Compliancy up to HDCP 2.2 and backward compliant
- › **Power Over HDBaseT:** Wall-plate (Tx) unit powered by Rx unit
- › **Installation:** Tx unit designed for installation in standard US dual-gang box
- › **Bandwidth:** TMDS bandwidth 10.2 Gbps
- › **Deep Color Support:** Up to UHD/4K 30Hz 4:2:2/12 bits or 60Hz 4:2:0/8 bit
- › **HDMI® and HDCP Licensing:** Fully licensed and compatible with HDCP 2.2 and HDMI latest technology such as 4K/UHD 4:2:0/8bit at 60f/s
- › **EDID Control:** Internal library features 15 default EDID configurations and native EDID data from Output/Display devices connected via Rx
- › **Full Buffer System™:** Manages TMDS re-clocking / signal re-generation, HDCP authentication with source & display, EDID Control handshake, and Hot Plug control
- › **RS-232:** Bi-Directional control to/from Tx and Rx unit



- › **IR Sensor:** Wall-plate collects line-of-sight IR from remote(s) without external IR wiring
- › **Unit Control Mode:** Provides RS-232 control and status of/from Tx unit
- › **Lossless compressed digital audio:** Support for Dolby® TrueHD, Dolby® Digital Plus, Dolby Atmos®, and DTS-HD Master Audio™
- › **CEC Support:** For inter-device control between input and output HDMI channel
- › **I2C Communication:** EDID and HDCP authentication to Display and Source
- › **Control System Support:** Fully controllable by all RS-232 supported control systems via open API: Compass Control® Pro, AMX®, Crestron®, KNX®, RTI®, Savant, URC®, Leviton® etc.

SPECIFICATIONS

- › Regulation: CE, RoHS, WEEE, EAC, EAC
- › Enclosure: Tx unit: Brushed aluminum face with black metal backing
Rx unit: Black metal
- › KD-SX440WPTx: 3.21" x 2.06" x 0.787" (Wall-plate), Weight: 0.7 lbs
- › KD-SX440Rx: 5.07" x 4.08" x 0.787", Weight: 0.4 lbs
- › KD-SX440Rx Power: 24V/1.25A (30W) Power Supply
- › Accessories: 24V 1.67A DC power supply (qty 1), Aluminum decora plate (qty 1), Decora mounting screws with flat head (qty 4), Gang-box mounting screws (qty 4), Mounting bracket (qty 2), IR Emitter (qty 1), 3-pin phoenix terminal (qty 2)

SYSTEM DESIGN EXAMPLE

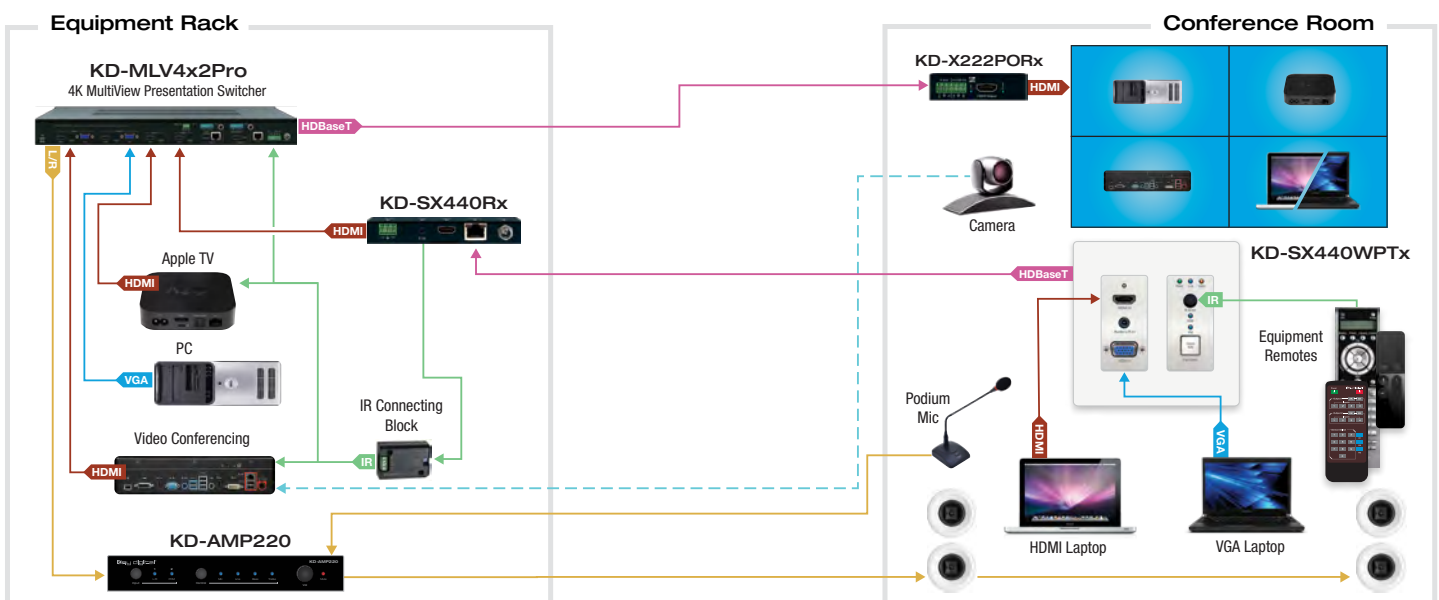

4K/18G HDBaseT Extenders

KD-X444L

4K/18G HDBT POH Extenders (Includes KIT Tx/Rx 4K/70meters 1080P/100meters)

KEY FEATURES

- › **HDBaseT via Single CAT5e/6 UTP/STP Extension:** With fully automatic adjustment of feedback, equalization, and amplification depending on cabling length
- › **4K Support:** 4096x2160 or 3840x2160 24/25/30/60hz at 4:4:4 (signals up to 18Gbps bandwidth)
- › **Flexible Power over HDBaseT:** Only one power connection needed. Tx may power Rx, or Rx may power Tx.
- › **Low Profile:** Super slim chassis design
- › **Signal Extension:** For resolution and cable quality
 - › **4K/UHD:** Up to 230 ft. (70m) using CAT5e/6
Up to 328 ft. (100m) using CAT6A STP / CAT7
 - › **1080p:** Up to 328 ft. (100m) maximum
- › **Long Range Mode:** Extends 1080p signals up to 500 ft. (152m) using CAT5e/6 (UHD/4K not supported)
- › **10G Pass-thru:** Mode enables uncompressed 10.2Gbps signal extension
- › **HDR10 (High Dynamic Range):** More life-like images through a greater range of luminance levels
- › **HDCP 2.2: Compliancy up to HDCP 2.2 and backward compliant**
- › **Deep Color Support:** Up to UHD/4K 30Hz 4:4:4/12 bits or 60Hz 4:4:4/8 bit
- › **EDID Control:** Internal library with 15 EDID handshakes including 4K with HDR in addition to native EDID data from Output/Display device connected to Rx
- › **Hot Plug Detection Control:** Enables integrator to choose if active signal voltage is forced to connected input and output devices
- › **Full Buffer System™:** Manages TMDS re-clocking / signal re-generation, HDCP authentication with source & display, EDID Control handshake, and Hot Plug Detection control
- › **IR Sensor:** Sensor powering via +5V on IR In ports collects line-of-sight IR from remote(s) without external IR connecting block
- › **Up/Down IR:** Two channels of IR enable control to/from devices or control systems connected to Tx and Rx units



- › **RS-232:** Bi-Directional control to/from Tx and Rx unit on Phoenix connector
- › **Lossless compressed digital audio:** Support for Dolby® TrueHD, Dolby® Digital Plus, Dolby Atmos®, and DTS-HD Master Audio™
- › **CEC Pass-thru:** For inter-device control between input and output HDMI channel

SPECIFICATIONS

- › **Inputs Tx (Each):** 1 HDMI, 1 IR, 1 RS-232
- › **Outputs Tx (Each):** 1 HDBaseT, 1 IR, 1 RS-232
- › **Inputs Rx (Each):** 1 HDBaseT, 1 IR, 1 RS-232
- › **Outputs Rx (Each):** 1 HDMI, 1 IR, 1 RS-232
- › **Regulation:** CE, RoHS, WEEE, EAC, EAC
- › **Enclosure:** Black Metal
- › **Product (Each):** 4.1" x 2.8" x 0.875", Weight: 0.75 lbs
- › **Power:** 48V/0.42A, 20W DC Power Supply (Screw-In Type)
- › **Accessories:** 4x Mounting Brackets, 1x IR Emitter, 1x IR Sensor, 1x 3-pin Phoenix Connector, 1x 4-pin Phoenix Connector

SYSTEM DESIGN EXAMPLE

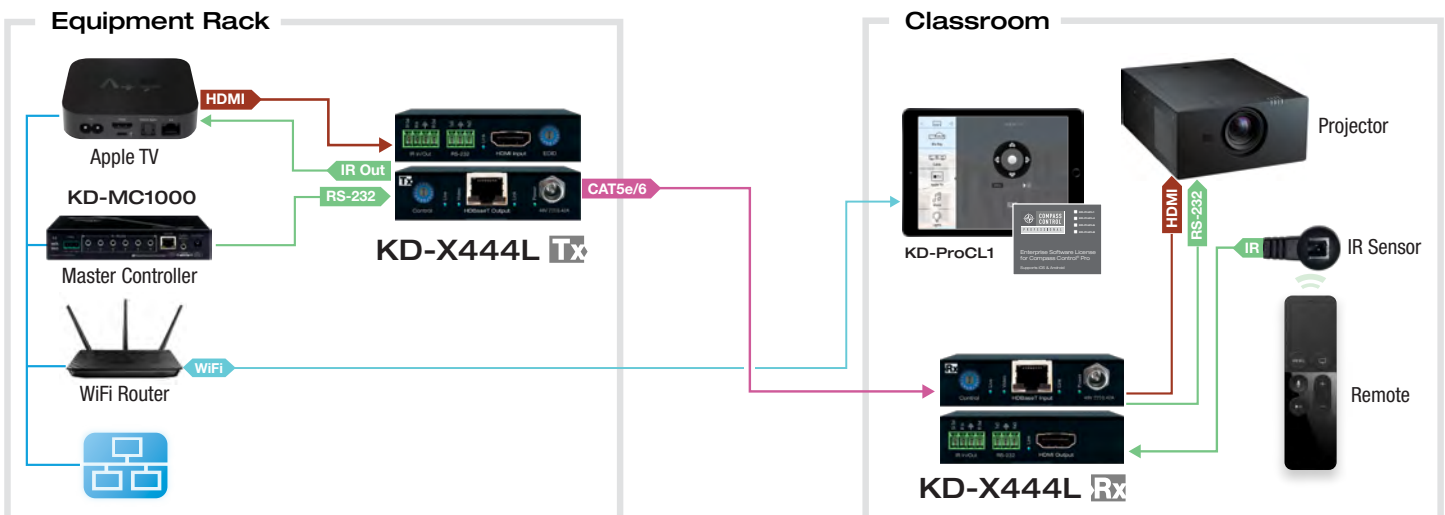

4K/18G HDBaseT Extenders

KD-X444S

4K/18G HDBT POH Extenders (Includes KIT Tx/Rx 4K/40meters 1080P/70meters)

KEY FEATURES

- › **HDBaseT via Single CAT5e/6 UTP/STP Extension:** With fully automatic adjustment of feedback, equalization, and amplification depending on cabling length
- › **4K Support:** 4096x2160 or 3840x2160 24/25/30/60hz at 4:4:4 (signals up to 18Gbps bandwidth)
- › **Flexible Power over HDBaseT:** Only one power connection needed. Tx may power Rx, or Rx may power Tx.
- › **Low Profile:** Super slim chassis design
- › **Signal Extension:** For resolution and cable quality
 - › **4K/UHD:** Up to 125 ft. (40m) using CAT5e/6
 - › **1080p:** Up to 230 ft. (70m) maximum (Valens VS10)
- › **10G Pass-thru:** Mode enables uncompressed 10.2Gbps signal extension
- › **HDR10 (High Dynamic Range):** More life-like images through a greater range of luminance levels
- › **HDCP 2.2:** Compliancy up to HDCP 2.2 and backward compliant
- › **Deep Color Support:** Up to UHD/4K 30Hz 4:4:4/12 bits or 60Hz 4:4:4/8 bit
- › **EDID Control:** Internal library with 15 EDID handshakes including 4K with HDR in addition to native EDID data from Output/Display device connected to Rx
- › **Hot Plug Detection Control:** Enables integrator to choose if active signal voltage is forced to connected input and output devices
- › **Full Buffer System™:** Manages TMDS re-clocking / signal re-generation, HDCP authentication with source & display, EDID Control handshake, and Hot Plug Detection control
- › **IR Sensor:** Sensor powering via +5V on IR In ports collects line-of-sight IR from remote(s) without external IR connecting block
- › **Up/Down IR:** Two channels of IR enable control to/from devices or control systems connected to Tx and Rx units
- › **RS-232:** Bi-Directional control to/from Tx and Rx unit on Phoenix connector
- › **Lossless compressed digital audio:** Support for Dolby® TrueHD, Dolby® Digital Plus, Dolby Atmos®, and DTS-HD Master Audio™
- › **CEC Pass-thru:** For inter-device control between input and output HDMI channel



SPECIFICATIONS

- › Inputs Tx (Each): 1 HDMI, 1 IR, 1 RS-232
- › Outputs Tx (Each): 1 HDBaseT, 1 IR, 1 RS-232
- › Inputs Rx (Each): 1 HDBaseT, 1 IR, 1 RS-232
- › Outputs Rx (Each): 1 HDMI, 1 IR, 1 RS-232
- › Regulation: CE, RoHS, WEEE, EAC, EAC
- › Enclosure: Black Metal
- › Product (Each): 4.1" x 2.8" x 0.875", Weight: 0.75 lbs
- › Accessories: 4x Mounting Brackets, 1x IR Emitter, 1x IR Sensor, 1x 3-pin Phoenix Connector, 1x 4-pin Phoenix Connector
- › Power: (1) 12V/1.66A, 20W DC Power Supply (Screw-In Type). 100-240VAC, 50-60Hz. Interchangeable transformer plug with screw-in connector. SKU: KD-PS20W12VQ

SYSTEM DESIGN EXAMPLE

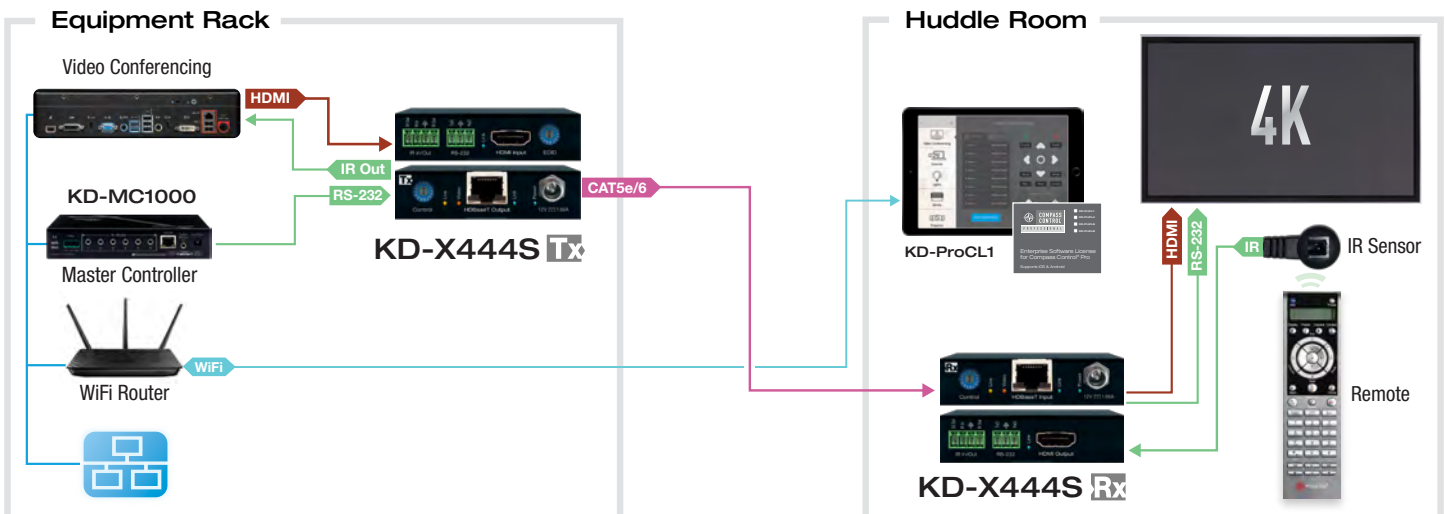

KD-X422POA

4K Power over HDBaseT/HDMI Extenders, Audio De-Embedding, HDR10, HDCP 2.2
(Includes KIT Tx/Rx)

KEY FEATURES

- ▶ **HDBaseT via Single CAT5e/6 UTP/STP Extension:** With fully automatic adjustment of feedback, equalization, and amplification depending on cabling length
- ▶ **4K/UHD Resolution:** Supports signals up to 4096x2160 60Hz [4:2:0] 8bit, 4096x2160 30Hz [4:2:2] 12bit, and 4096x2160 30Hz [4:4:4] 8bit
- ▶ **Power Over HDBaseT:** Features power extension from Tx to Rx with Power Over HDBaseT, Rx unit does not require power supply
- ▶ **Signal Extension:**
 - » Up to 150 ft. @ 4K 24/25/30(4:4:4)/60(4:2:0) using KD-CAT6STP1X cabling
 - » Up to 125 ft. @ 4K 24/25/30(4:4:4)/60(4:2:0) using third-party CAT5e/6 UTP/STP cabling
 - » Up to 250 ft. @ 1080p / 1920x1200 using KD-CAT6STP1X cabling
 - » Up to 230 ft. @ 1080p / 1920x1200 using third-party CAT5e/6 cabling
- ▶ **HDCP 2.2:** Compliancy up to HDCP 2.2 and backward compliant
- ▶ **HDR10 (High Dynamic Range):** More life-like images through a greater range of luminance levels
- ▶ **Deep Color Support:** Up to UHD/4K 30Hz 4:2:2/12 bits or 60Hz 4:2:0/8 bit
- ▶ **HDMI® and HDCP Licensing:** Fully licensed and compatible with HDCP 2.2 and HDMI latest technology such as 4K/UHD 4:2:0/8bit at 60f/s
- ▶ **EDID Control:** Internal library features 15 default EDID configurations and native EDID data from Output/Display devices connected via Rx
- ▶ **Hot Plug Detection Control:** Enables integrator to choose if active signal voltage is forced to connected input devices
- ▶ **Full Buffer System™:** Manages TMDS re-clocking / signal re-generation, HDCP authentication with source & display, EDID Control handshake, and Hot Plug control
- ▶ **Low Profile:** Super slim chassis design
- ▶ **IR Sensor:** Sensor powering via +5V on Tx unit's IR In port collects line-of-sight IR from remote(s) without external IR connecting block



- ▶ **Up/Down IR:** Two channels of IR enable control to/from devices connected to Tx and Rx units
- ▶ **RS-232:** Bi-Directional control to/from Tx and Rx unit on Phoenix connector
- ▶ **Rotary Switch RS-232 Control Mode:** Provides control of Tx unit as well as connectivity status
- ▶ **Lossless compressed digital audio:** Support for Dolby® TrueHD, Dolby® Digital Plus, Dolby Atmos®, and DTS-HD Master Audio™
- ▶ **CEC Support:** For inter-device control between input and output HDMI channel
- ▶ **I2C Communication:** EDID and HDCP authentication to Display and Source
- ▶ **Control System Support:** Fully controllable by all RS-232 supported control systems via open API: Compass Control® Pro, AMX®, Crestron®, KNX®, RTI®, Savant, URC®, Leviton® etc.

SPECIFICATIONS

- ▶ Regulation: CE, RoHS, WEEE, EAC
- ▶ Enclosure: Black Metal
- ▶ Product (Each): 5" x 4.06" x 1.06", Weight: 0.5 lbs
- ▶ Power (Tx Only): KD-PS12V2ASC, 12V/2A, 100-240VAC, 50-60Hz, Interchangeable head with screw-in connector
- ▶ Accessories: (2) Mounting brackets, (1) IR emitter, (1) IR sensor, (1) 6 pin terminal plug, (2) 3 pin terminal plug

SYSTEM DESIGN EXAMPLE

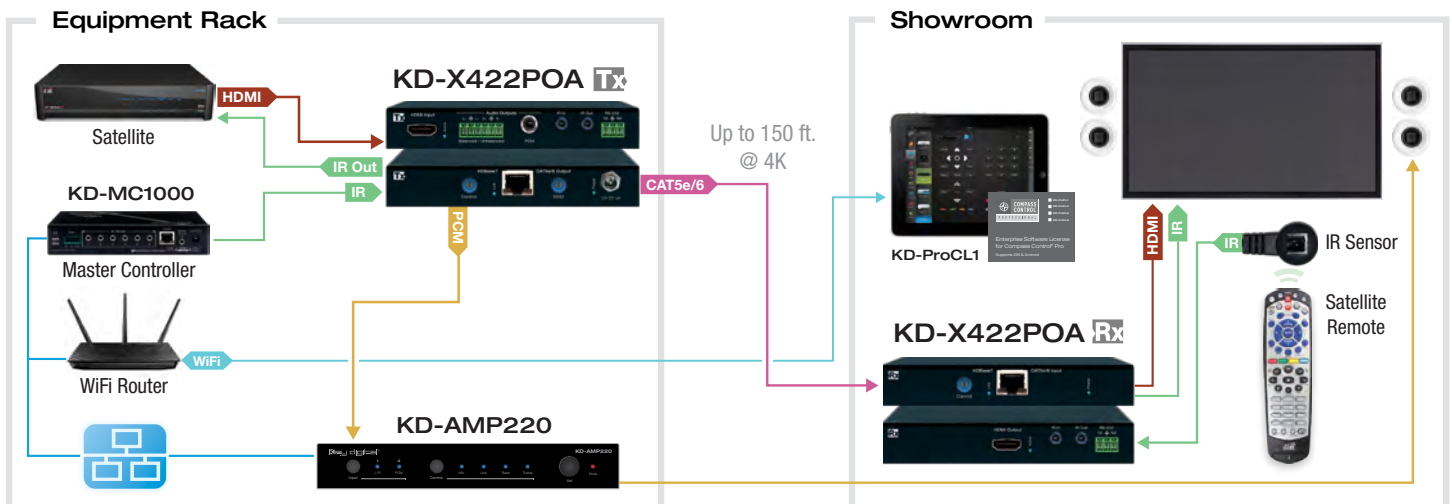

* For all installations, we highly recommend use of KD-CAT6STP1X STP cabling, especially in hostile electrical environments. The shield of CAT6STP must be soldered on both ends to the shield of RJ45 connector used. The CAT5/5e/6 cable has to be terminated according to TIA/EIA-568-B standard. The use of STP CAT5, 5e is not recommended.

KD-X222PO

4K Power over HDBaseT/HDMI Extenders, HDR, HDCP2.2 (Includes KIT Tx/Rx)

KEY FEATURES

- **HDBaseT via Single CAT5e/6 UTP/STP Extension:** With fully automatic adjustment of feedback, equalization, and amplification depending on cabling length
- **4K/UHD Resolution:** Supports signals up to 4096x2160 60Hz [4:2:0] 8bit, 4096x2160 30Hz [4:2:2] 12bit, and 4096x2160 30Hz [4:4:4] 8bit
- **KD-X222PO:** Features power extension from Tx to Rx with Power Over HDBaseT, Rx unit does not require power supply
- **Signal Extension:**
 - » Up to 150 ft. @ 4K 24/25/30(4:4:4)/60(4:2:0) using KD-CAT6STP1X cabling
 - » Up to 125 ft. @ 4K 24/25/30(4:4:4)/60(4:2:0) using third-party CAT5e/6 UTP/STP cabling
 - » Up to 250 ft. @ 1080p / 1920x1200 using KD-CAT6STP1X cabling
 - » Up to 230 ft. @ 1080p / 1920x1200 using third-party CAT5e/6 cabling
- **HDCP 2.2:** Compliancy up to HDCP 2.2 and backward compliant
- **HDR (High Dynamic Range):** More life-like images through a greater range of luminance levels
- **Deep Color Support:** Up to UHD/4K 30Hz 4:2:2/12 bits or 60Hz 4:2:0/8 bit
- **Low Profile:** Super slim chassis design
- **HDMI® and HDCP Licensing:** Fully licensed and compatible with HDCP 2.2 and HDMI latest technology such as 4K/UHD 4:2:0/8bit at 60f/s
- **EDID Control:** Internal library features 15 default EDID configurations and native EDID data from Output/Display devices connected via Rx
- **Hot Plug Detection Control:** Enables integrator to choose if active signal voltage is forced to connected input devices
- **Full Buffer System™:** Manages TMDS re-clocking / signal re-generation, HDCP authentication with source & display, EDID Control handshake, and Hot Plug control
- **IR Sensor:** Sensor powering via +5V on Rx unit's IR In port collects line-of-sight IR from remote(s) without external IR connecting block
- **Up/Down IR:** Two channels of IR enable control to/from devices connected to Tx and Rx units



- **RS-232:** Bi-Directional control to/from Tx and Rx unit on Phoenix connector
- **Rotary Switch RS-232 Control Mode:** Provides control of Tx unit as well as connectivity status
- **Lossless compressed digital audio:** Support for Dolby® TrueHD, Dolby® Digital Plus, Dolby Atmos®, and DTS-HD Master Audio™
- **CEC Support:** For inter-device control between input and output HDMI channel
- **I2C Communication:** EDID and HDCP authentication to Display and Source
- **Control System Support:** Fully controllable by all RS-232 supported control systems via open API: Compass Control® Pro, AMX®, Crestron®, KNX®, RTI®, Savant, URC®, Leviton® etc.

SPECIFICATIONS

- » Regulation: CE, RoHS, WEEE, EAC
- » Enclosure: Black Metal
- » Product (Each): 4.1" x 2.8" x 0.875", Weight: 0.75 lbs
- » Power (Tx Only): KD-PS12V2ASC, 12V/2A, 100-240VAC, 50-60Hz, Interchangeable head with screw-in connector
- » Accessories: (2) Mounting Brackets, (1) IR Emitter, (1) IR Sensor

SYSTEM DESIGN EXAMPLE

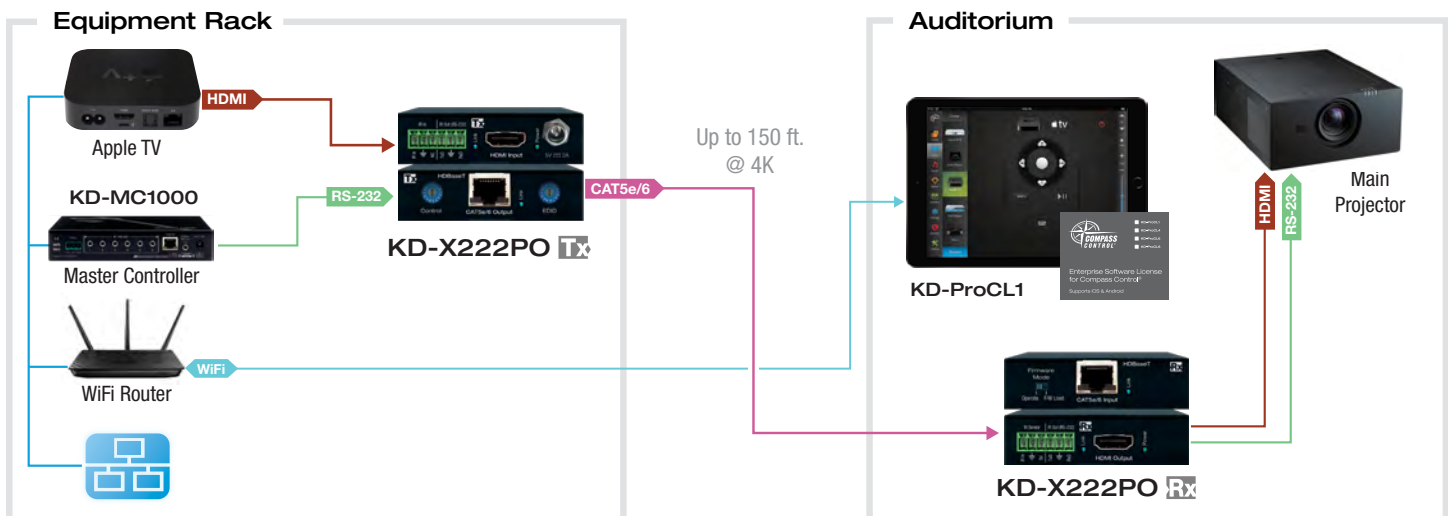

* For all installations, we highly recommend use of KD-CAT6STP1X STP cabling, especially in hostile electrical environments. The shield of CAT6STP must be soldered on both ends to the shield of RJ45 connector used. The CAT5/5e/6 cable has to be terminated according to TIA/EIA-568-B standard. The use of STP CAT5, 5e is not recommended.

Video Converters & Scalers

KD-VCS500

Video Converter and Scaler

KEY FEATURES

- › **Converts:** VGA video and analog audio to digital HDMI video and audio
- › **Embeds:** Incoming analog audio onto the HDMI output
- › **Up-scales:** VGA resolutions to 720p or 1080p
- › **Supports the following VGA resolutions:**
 - › 640x480@60,
 - › 800x600@60,
 - › 1024x768@60,
 - › 1152x864@60Hz,
 - › 1280x720@60, 1280x768@60, 1280x800@60, 1280x960@60,
 - › 1360x768@60, 1366x768@60, 1280x960@60, 1280x1024@60,
 - › 1440x900@60/75, 1600x1050@60, 1680x1050@60, 1600x1200@60,
 - › 1920x1080@60, 1920x1200@60
- › **Resolution Selection:** Simple switching between 720p and 1080p up-scaling
 - › Dual-color LED allows for easy identification of resolution mode
- › **HDMI® and HDCP Licensing:** Fully licensed and compatible with all HDMI and HDCP technologies
- › **Ultra small design**



SPECIFICATIONS

- › Inputs: (1) VGA, (1) 3.5mm stereo audio
- › Outputs: 1 HDMI
- › DDC Signal (Data): 5 Volts p-p (TTL)
- › DDC Communication: EDID and HDCP Bi-directional transparency from Display to Source
- › Power Supply: KD-PS5V1A, 5V/1A, 100-240VAC, 50-60Hz, Interchangeable head
- › Regulation: CE, RoHS, WEEE, EAC
- › Enclosure: Black Plastic
- › Product Dimensions: 4.68" x 2.91" x 0.9", Weight: 0.8 lbs.
- › Shipping Dimensions: 7" x 5.3" x 2.6", Weight: 1 lb.

SYSTEM DESIGN EXAMPLE

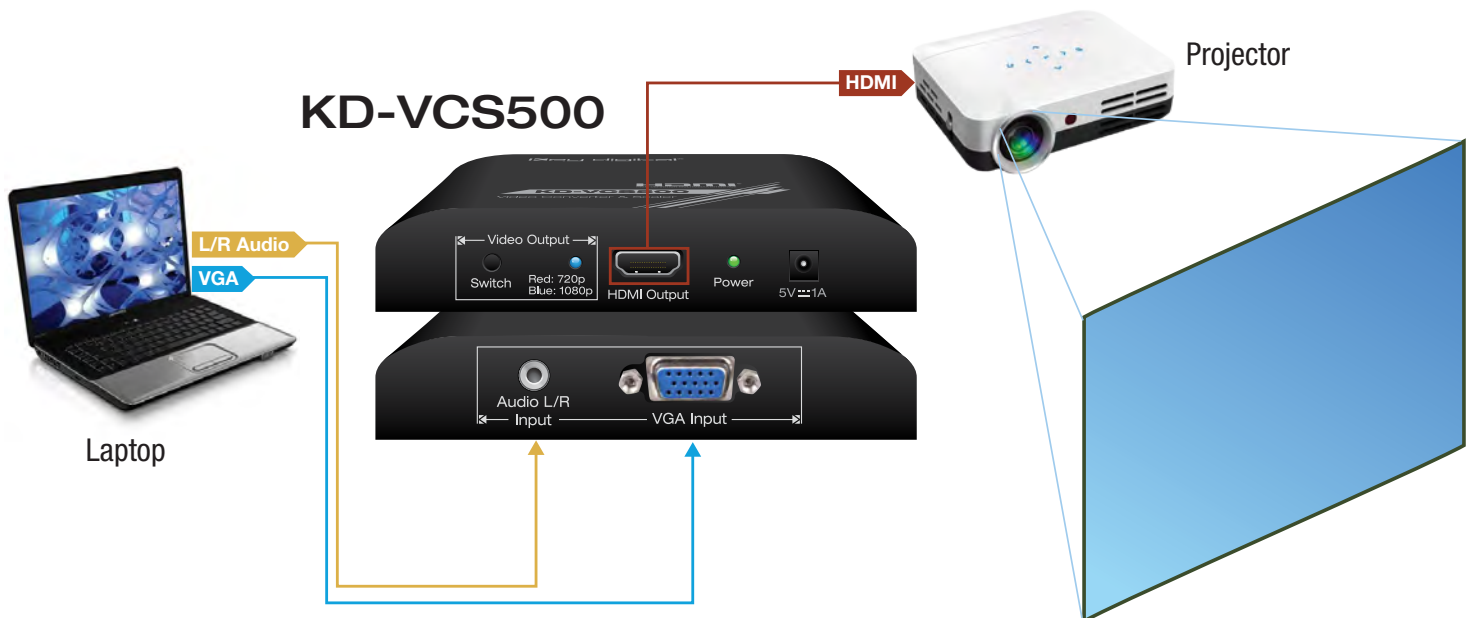



KD-MAX8x8

8x8 Audio Matrix Switcher with built-in Audio DSP

KEY FEATURES

- » **Multi-format Audio Multiplexing:** DSP per output for independent matrix selection
 - » Analog to Analog Matrix with DSP
 - » Digital to Analog Matrix with DSP
 - » Digital to Digital Matrix
 - » Analog to Digital Matrix
- » **Audio DSP:** Variable level settings for volume, muting, 3-band EQ, balance, and lip-sync delay per balanced output
- » **Audio Delay:** Variable level set from 0ms to 170ms
- » **Audio Conversion:** Analog to digital. Digital to analog
- » **Balanced or Unbalanced:** Input audio type may be specified per input
- » **Lossless Compressed Digital Audio:** Dolby® and DTS surround up to 5.1ch pass-thru
- » **Long Cable Runs:** Enabled by balanced audio connection, signals may be run up to 1,000 ft.
- » **Expansion Configurations:** Custom configurations available for incrementally expansion using multiple units
 - » Up to 8 sources/inputs with up to 64 zones/outputs
 - » Up to 16 sources/inputs with up to 64 zones/outputs
 - » Up to 24 sources/inputs with up to 32 zones/outputs
 - » Up to 32 sources/inputs with up to 32 zones/outputs
- » **Control Integration:** TCP/IP, RS-232, and USB with full bi-directional operation, front panel push buttons and LEDs, front/rear optical IR, serial IR,
- » **Control System Support:** Key Digital® App ready, Compass Control® Pro ready, KD-Wizard® ready. Fully controllable by all IR, RS-232, and TCP/IP supported control systems via open API: AMX®, Crestron®, Control4®, KNX®, RTI®, Savant®, URC®, Leviton® etc.
- » **Key Digital® App Ready:** Scan & detect population for pre-built GUI and TCP/IP control via Key Digital® App



SPECIFICATIONS

- » Input (each): Balanced/unbalanced line level audio on 6-pin terminal block. Accepts 2VRMS line audio input with a sampling rate of 48KHz
- » Input (each): RCA female for digital audio following SPDIF format (IEC 60958). Supports sampling rate up to 192KHz
- » Output (each): Balanced/unbalanced line level audio on 6-pin terminal block. Drives 2VRMS line audio input with a sampling rate of 48KHz
- » Output (each): RCA female for digital audio following SPDIF format (IEC 60958). Supports sampling rate up to 192KHz
- » Regulation: CE, RoHS, WEEE, EAC
- » Rack Mount: 1U, 1 Rack Width (rack ears included)
- » Enclosure: Black Metal
- » Product Dimensions: 17.5" x 7" x 1.75"
- » Shipping Carton Dimensions: 23.5" x 11" x 4.5"
- » Product Weight: 6 lb
- » Shipping Weight: 9 lb.

SYSTEM DESIGN EXAMPLE

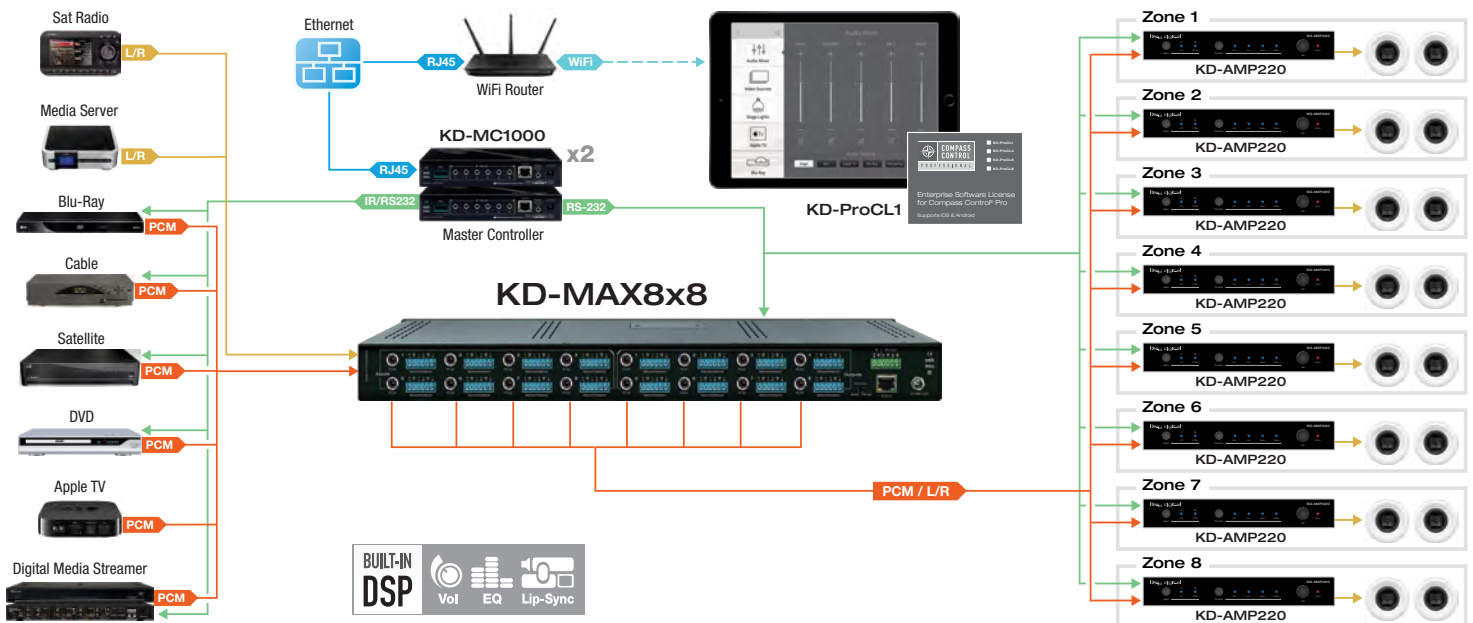

Digital Audio Amplifiers

KD-AMP220

2Ch 20 WPC @ 8 Ohm, 40 WPC @ 4 Ohm, Compact Digital Audio Amplifier

KEY FEATURES

- › **Class D Amplification:** 2Ch 20 WPC @ 8 Ohm, 40 WPC @ 4 Ohm, bridged
- › **Mixing:** Output is a mix of microphone and the selected audio input
- › **Signal Processing:**
 - › Variable volume level set for each input
 - › Variable volume, bass, and treble for output
- › **Inputs:** Microphone (3-pin balanced, condenser/dynamic), 6-pin balanced stereo, 3.5mm stereo
- › **Phantom Power:** 48V phantom power for integration with condenser microphones
- › **Outputs:** Pre-amp line level (6-pin balanced), speaker level
- › **Speaker Level Output:** Bridge, stereo, or mono modes selectable
- › **Noise gate:** For consistent audio levels, prevention of ambient noise
- › **Control:** Front panel, RS-232, IR with external IR Sensor (included)
- › **Compact Size:** 4.84"(W) x 3.42"(D) x 1.3"(H)



SPECIFICATIONS

- › Frequency Response: 20Hz – 20KHz
- › Signal to Noise Ratio: <80dB
- › Total Harmonic Distortion: <1% @ 1KHz, <0.3% @ 20KHz
- › Input Impedance:
 - › Mic: 35Ω with 48V phantom power applied, 10K Ω without
 - › Line: >10K Ω
- › Output Impedance:
 - › Speaker: 4Ω – 8Ω
 - › Line: 50Ω

ADVANCED SYSTEM DESIGN EXAMPLE

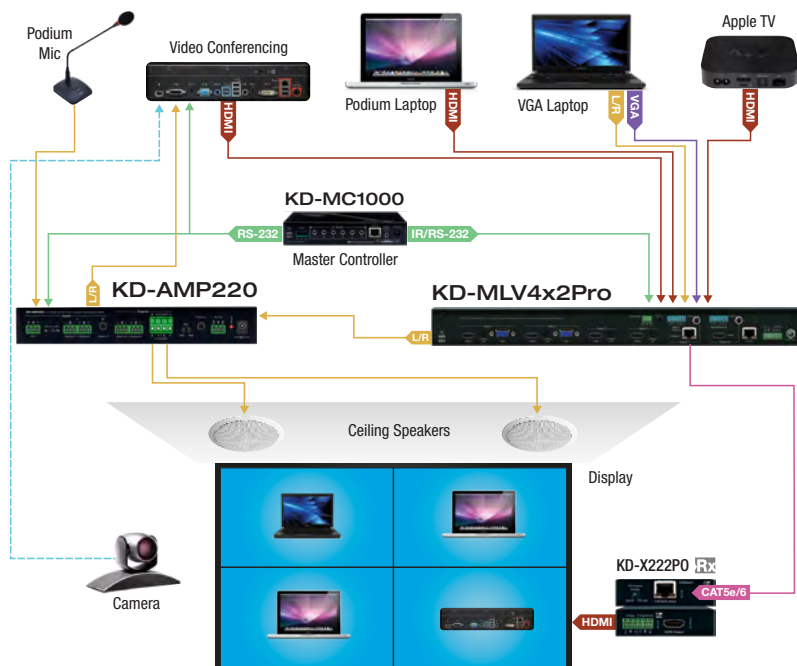

BASIC SYSTEM DESIGN EXAMPLE

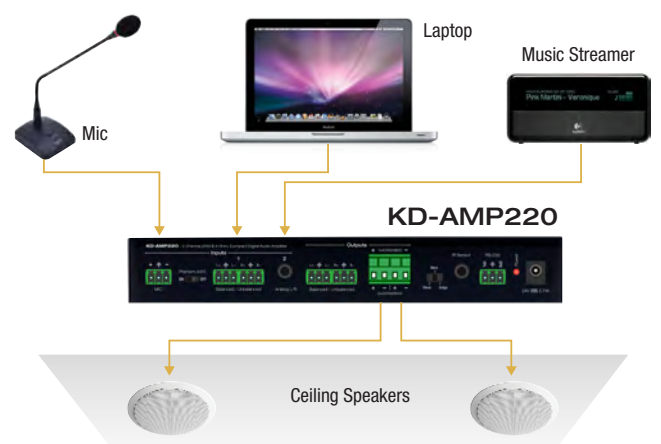

Commercial-Grade HDMI Cables

4K/18G Commercial-Grade HDMI Cables – VW1 UL Rated

4K/18G HDMI Cables, HDR10, HDCP 2.2, Ethernet, ARC - VW1 UL Rated

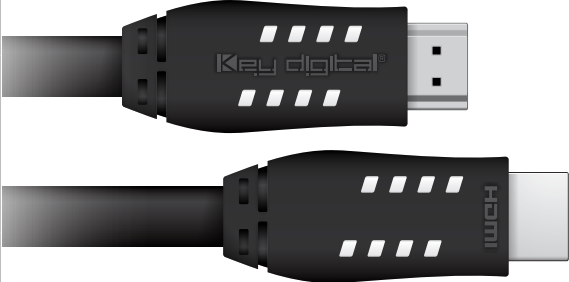
KD-Pro3	3 ft. HDMI Cable	28 AWG	
KD-Pro6	6 ft. HDMI Cable	28 AWG	
KD-Pro9	9 ft. HDMI Cable	26 AWG	

4K**18 Gbps**
HIGH
BANDWIDTH**444**
60Hz**HDR 10**
HIGH DYNAMIC
RANGE**HDCP**
2.2**100 Mb/s**
ETHERNET
CHANNEL**ARC**
AUDIO RETURN
CHANNEL**VW1**
UL RATED

KEY FEATURES

- > **4K/UHD Support:** 4096x2160 or 3840x2160 50/60Hz at 4:4:4
- > **18 Gbps Bandwidth:** High Speed / Performance for latest HDMI standards
- > **High Dynamic Range (HDR) Format Support:** HDR10 and Dolby® Vision
- > **HDCP 2.2:** Compliancy up to HDCP 2.2 and backward compliant
- > **Ethernet Channel:** 100 Mb/s Ethernet between two HDMI connecting devices
- > **Audio Return Channel:** Audio can be returned from display back to HDMI source for amplification and display
- > **Deep Color Support:** Up to UHD/4K 24/25/30Hz 4:4:4/12 bits or 50/60Hz 4:2:0/12 bit

- > **OPEN EYE™ Technology:** Certified & tested for low loss and noise-free performance
- > **Support All Digital Audio Formats:** Dolby® TrueHD, Dolby® Digital Plus, Dolby® Atmos and DTS-HD Master Audio™

OPEN
EYE **DOLBY**®**HDMI**®
HIGH-DEFINITION MULTIMEDIA INTERFACE

HDMI is a registered trademark of HDMI Licensing, LLC. Dolby is a registered trademarks of Dolby Laboratories. DTS-HD Master Audio is a trademark of DTS, Inc.

Key digital™

521 East 3rd Street • Mount Vernon, NY 10553 • Phone: 914.667.9700 • www.keydigital.com

Commercial-Grade HDMI Cables

4K/18G Commercial-Grade HDMI Cables – CL3/FT4 UL Rated

4K/18G HDMI Cables, support HDR10, HDCP 2.2, Ethernet - CL3/FT4 UL Rated

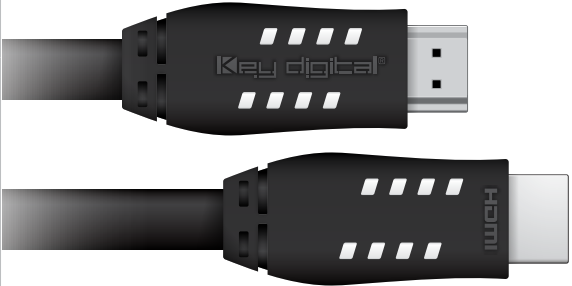
KD-Pro12	12 ft. HDMI Cable	26 AWG	
KD-Pro16	16 ft. HDMI Cable	26 AWG	
KD-Pro20	20 ft. HDMI Cable	24 AWG	



KEY FEATURES

- > **4K/UHD Support:** 4096x2160 or 3840x2160 50/60Hz at 4:4:4
- > **18 Gbps Bandwidth:** High Speed / Performance for latest HDMI standards
- > **High Dynamic Range (HDR) Format Support:** HDR10 and Dolby® Vision
- > **HDCP 2.2:** Compliancy up to HDCP 2.2 and backward compliant
- > **Ethernet Channel:** 100 Mb/s Ethernet between two HDMI connecting devices
- > **Audio Return Channel:** Audio can be returned from display back to HDMI source for amplification and display
- > **Deep Color Support:** Up to UHD/4K 24/25/30Hz 4:4:4/12 bits or 50/60Hz 4:2:0/12 bit

- > **OPEN EYE™ Technology:** Certified & tested for low loss and noise-free performance
- > **Support All Digital Audio Formats:** Dolby® TrueHD, Dolby® Digital Plus, Dolby® Atmos and DTS-HD Master Audio™



HDMI is a registered trademark of HDMI Licensing, LLC. Dolby is a registered trademarks of Dolby Laboratories. DTS-HD Master Audio is a trademark of DTS, Inc.



521 East 3rd Street • Mount Vernon, NY 10553 • Phone: 914.667.9700 • www.keydigital.com

Plenum Active Optical HDMI Fiber Cables

4K@60Hz/444/18G - Plenum, CMP/FT6 Rated

KD-AOCH33P	33 ft. / 10 m	
KD-AOCH49P	49 ft. / 15 m	
KD-AOCH66P	66 ft. / 20 m	
KD-AOCH98P	98 ft. / 30 m	
KD-AOCH131P	131 ft. / 40 m	
KD-AOCH164P	164 ft. / 50 m	
KD-AOCH328P	328 ft. / 100 m	



KEY FEATURES

- ▶ **CMP/FT6 UL Rating:** Fire retardant jacket is approved for installation in Plenum spaces
- ▶ **Active Optical Cable (AOC):** Technology carries heavy TMDS HDMI channel over fiber
- ▶ **4K/UHD Support:** 4096x2160 or 3840x2160 50/60Hz at 4:4:4
- ▶ **18 Gbps Bandwidth:** High Speed / Performance for latest HDMI standards
- ▶ **High Dynamic Range (HDR) Format Support:** HDR10 and Dolby® Vision
- ▶ **HDCP 2.2:** Compliancy up to HDCP 2.2 and backward compliant
- ▶ **Ethernet Channel:** 100 Mb/s Ethernet between two HDMI connecting devices
- ▶ **Audio Return Channel:** Audio can be returned from display back to HDMI source for amplification and display
- ▶ **Deep Color Support:** Up to 4K 24/25/30Hz 4:4:4/12 bits or 50/60Hz 4:2:0/12 bit
- ▶ **Directional Cable:** Each head contains specific handling for optimal performance
- ▶ **OPEN EYE™ Technology:** Certified & tested for 0% loss and noise-free performance
- ▶ **Support All Digital Audio Formats:** Dolby® TrueHD, Dolby® Digital Plus, Dolby® Atmos and DTS-HD Master Audio™
- ▶ **Thin & Flexible:** Wiring supports tighter bend radius than traditional HDMI
- ▶ **Powered by HDMI:** No external powering
- ▶ **Pull Strength:** Fiber Optic Cable = 33lb / 15kg. Connector = 53lb / 24kg
- ▶ **Cable Gage:** 28 AWG

HDMI is a registered trademark of HDMI Licensing, LLC. Dolby is a registered trademarks of Dolby Laboratories. DTS-HD Master Audio is a trademark of DTS, Inc.



Encompass360™

Complete Built-to-Order Solutions from the expert system integrators at Key Digital

Key Digital's Encompass360™ program is designed to deliver exactly what integrators have been looking for – a new way to design, specify, integrate and then quickly deliver and install in hours install large complex systems. To simplify this process this we have broken down the Encompass360™ program into five stages:



Consult Our engineers and programmers will work hand in hand with you going over your project's timeline, goals and budget while looking over the project's blueprints free of charge¹. We will discuss the optimal wiring design, sources² and displays for each room to provide the best results to meet and exceed your client's expectations for the intended system functionality. We'll go over the control needs and design the most cost effective Compass Control® System to address the system parameters.



Design We will take everything that was discussed in the Consult stage and provide you with a detailed system design and project line diagram. You are also going to be provided an example of the Compass Control® user interface for your project to give both yourself and client an idea on how their system is going to be laid out. If there is a scope of work change or system details that need to be changed then this would be the time to do it before moving to the next stage.



Build Once the Design is signed off on, we will begin to assemble and rack mount the hardware in the Build stage. If you have a custom rack that you would like to use for the project you could ship it to our Engineering Lab or we will provide a standard rack for you. Once the hardware is installed and wired up it will be put through a 24 hour test cycle to ensure everything is working 100% before moving on to the final two stages. Our programming team will begin building and testing the Compass Control® System template that is customized to this project requirements and design.



Integrate In the Integration stage, we will combine the Compass Control® System with the hardware in the rack. Once the two systems are brought together we will run the system through a thorough test cycle to ensure that the system configuration and functionality is 100%. With Key Digital's reputation for not settling for anything less than perfection, you can rest assured that this system has been tested and looked over several times before it gets signed off to move onto the final stage.



Deliver Finally we will take the complete rack mounted system and place it in a crate for shipping to your office or job site. Remember you are going to be receiving a complete turnkey solution. So, once you receive the rack all you will have to do is unpack it and make the final display and subsystem connections prior to turning the system over to your client.



For more information on getting the process started please contact our Sales Managers:

➤ Email: sales@keydigital.com or call (914) 667-9700 Option 2

¹ Key Digital provides this service free of charge to its dealers and is not responsible for the implementation or installation quality on the project site as this is the responsibility of the installing company.

² Key Digital is not responsible for any issues with a 3rd party manufacturer product. These issues must be taken up with said manufacturer for resolution.

³ Key Digital will not be on the project site to supervise during final installation and is no way responsible for the quality of this integration.

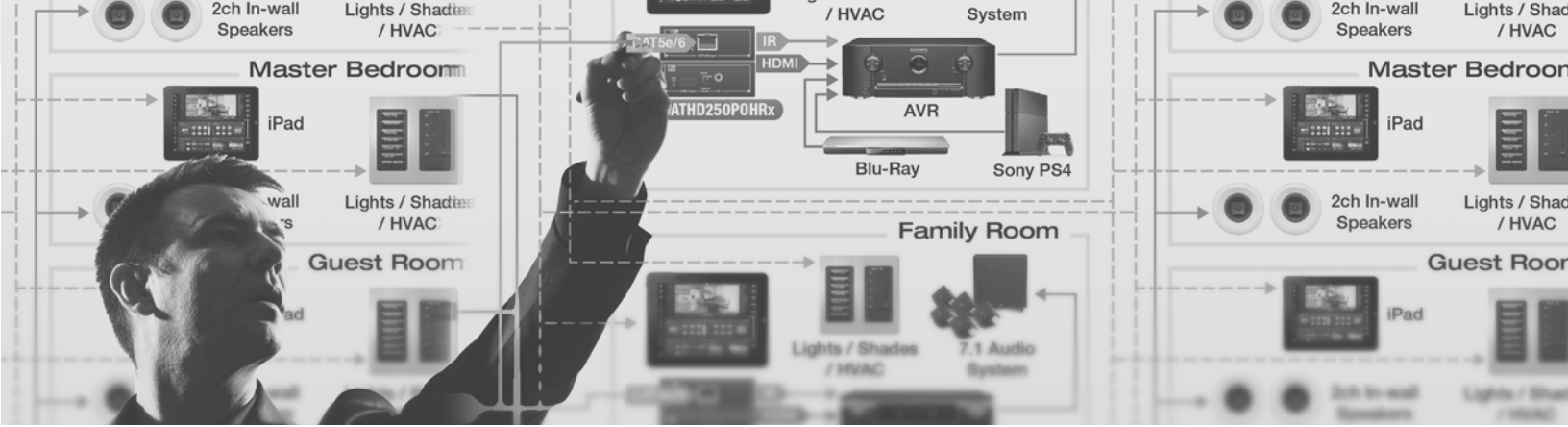

Key Digital® System Design Group - FREE* Expert System Design Services at Your Fingertips.

Designing a high quality, fully integrated video/audio processing, switching, distribution & control system can be a difficult and time-consuming task even for the experienced installer. We value our customers and offer system design services FREE* to our dealers and resellers.

Our professional System Design Group (SDG) has over 50 years of combined experience with virtually all types of video systems. The SDG department can provide the expertise to both choose the components and design a system that will provide the utmost in quality and functionality. Whether you need to modify a video system that is currently in place, or design a totally new system, we will work through your project and provide information, product choices, block diagrams, and pictures to make sure that all the needs of the project are met.

TO GET STARTED WITH A SYSTEM DESIGN REQUEST:

- > Complete the System Design Questionnaire and email to SDG Group: SDG@keydigital.com
- > Or Call System Design Group at 914-667-9700 option 3

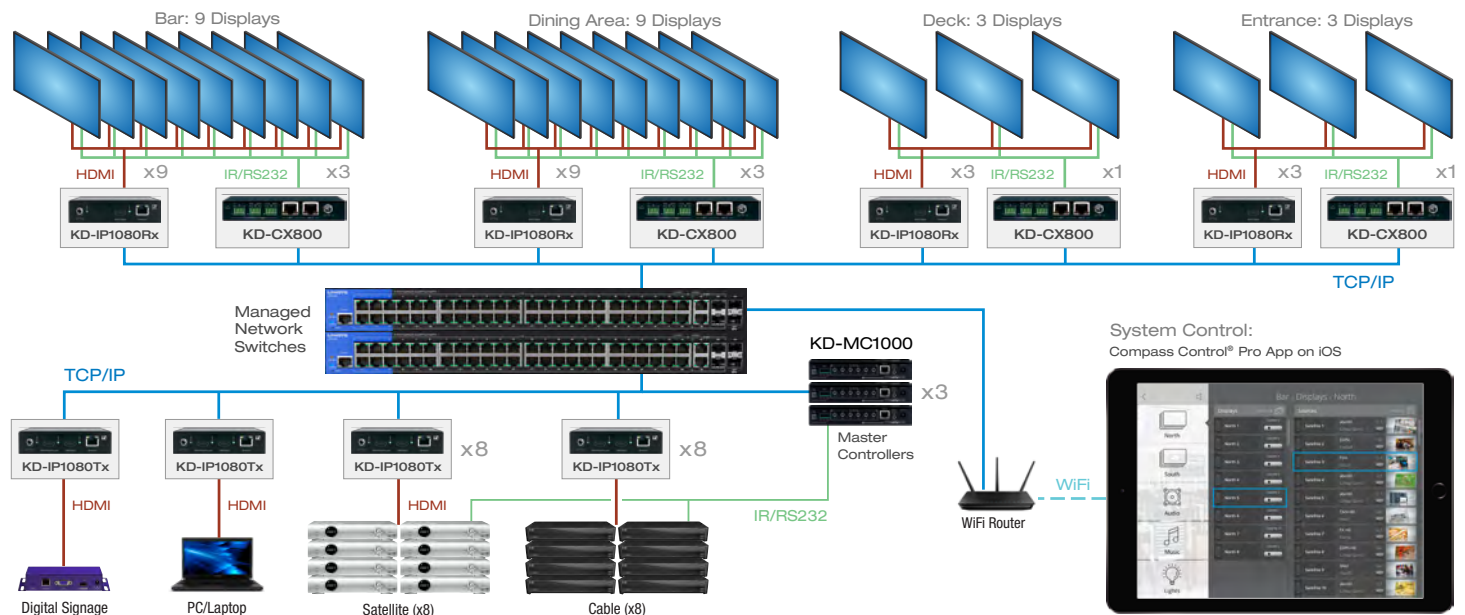

*Key Digital System Design Services are ONLY FREE to Authorized Key Digital Dealers, Resellers and Distributors purchasing system-specified products. Key Digital has zero-tolerance policy concerning dealers & distributors who are engaged in "bait & switch" tactics via requesting FREE system design services and then substituting with non- Key Digital products. This scenario violates Key Digital policy and agreements, and such dealers will be invoiced \$1,500 for SDG service which must be paid immediately.



Key Digital® Trainings - Translating customer education into customer success.

At Key Digital we have developed the most progressive and comprehensive training program for our dealers, offering access to designing, building, installing high-end commercial and residential installations, while being immersed in the features and benefits of all Key Digital products.

In-House Trainings are exclusive 2-3 day sessions aimed at advancing our dealers quickly through training and certifications. These trainings provide basic, intermediate, and advanced courses complete with certification exams in the span of a few days. Compass Control® trainings allow our dealers to become Compass Control® Certified Dealers and Programmers, giving them access to one of the most advanced control systems on the market.

Online Trainings & Certifications are FREE to our dealers and resellers and offer convenience and 24/7 access to a variety of training materials and certifications aimed at improving technical product knowledge, and educating about custom system design and programming.

InfoComm International RU Industry Certifications – All of our trainings and certification offer industry-standard certification units through InfoComm International RU Renewal Units.

On The Road Trainings are organized and held in conjunction with our resellers and distributors and held at their locations. Our training experts host these sessions and are focused on distributor specific products lines and offerings.



“All Key Digital products are designed and rigorously tested at our HQ in Mount Vernon, NY. Our trainers, tech support and engineers are working together on product definition and testing. That creates a direct line between our customers and actual technology used inside our products. That is why we can always give most in-depth information about our products and state of the art in technology during our trainings.” – Mike Tsinberg, CEO and Founder

Webinar Series provide personalized access to our experts with introductions to new products, in-depth discussion of technologies, category overviews, and designing the sort of full-scale systems that have made Key Digital's System Design Group (SDG™) very popular amongst industry insiders.

YouTube Video Trainings offer unlimited access to a ever-expanding library of FREE training resources available through mobile and desktop platforms. Visit and subscribe to Key Digital YouTube Channel for products training videos, software overviews, demos, and reviews.

Innovation Timeline

Mike Tsinberg, Founder and President of Key Digital, holder of 41 HDTV patents



- > “Father of DVD” - Developed architecture and system software for world first Digital Video Disk (DVD) MPEG2 based authoring system
- > 2009 Inductee as one of the Top 200 Pioneers of HDTV by the Academy of DTV Pioneers (CEA)
- > Participated with Emmy Award Winner for DVD technology development

2017

- > Compass Control® Pro Launched

2016

- > Enterprise AV™ over IP Video Wall Solutions released

2015

- > Patent: [System and method for transmitting control signals over HDMI](#)

2013

- > Received 2013 Adele De Berri Pioneers Award at InfoComm 2013

2012

- > Release of Compass Control® the first fully integrated major control system built from the ground up to use Apple's iOS 5 devices – as its backbone.

2010

- > Plug and Play vs. Plug and Pray – HDMI Buffering Method introduced

2009

- > Key Digital® 1 Key Technology Introduced: HDCP authentication technology
- > Noise-free OPEN EYE™ Technology implemented on all Key Digital® HDMI Products

2008

- > Introduction of first HDMI Distribution Amplifier with EDID Control, HDMI2x4P
- > Release of first Matrix Switcher with Video/Audio/Control via Single CAT5/6

2006

- > Introduction of first HDMI Switcher, and First HDTV Matrix Switcher

2002

- > Release of KD-HDLEEZA, First 1080p Scaler

2001

- > Patent: [Multi-channel electronic programming guide and soft picture-in-picture acquisition for use with digital television](#)

2000

- > Patent: [Method and system for interpolating a missing pixel using a motion vector](#)

1999

- > Key Digital founded by Mike Tsinberg, first product release, KD-DA12 for Best Buy
- > Received Emmy Award for DVD Technology Development as a member of Toshiba team

1998

- > Patent: [Audiovisual encoding system with a reduced number of audio encoders](#)
- > Patent: [Method and system for a user to manually alter the quality of previously encoded video frames](#)
- > Patent: [High definition video decoding using multiple partition decoders](#)
- > Patent: [High data rate system and method for video recording and playback](#)

1997

- > Chair, National Academy Of Television Arts & Sciences (NATAS) sub-committees on motion estimation technology and Digital TV bit stream analyzers 1997-2000
- > Patent: [System for deinterlacing digitally compressed video and method](#)
- > Patent: [Method and system for a user to manually alter the quality of a previously encoded video sequence](#)
- > Patent: [Digital video recording and playback system and method having multiple playback devices outputting video program data on multiple channels](#)

1996

- > Member of SMPTE (Society of Motion Picture & Television Engineers)
- > Patent: [Video compression system with editing flag](#)
- > Patent: [Apparatus for processing band-compressed signals having inter-frame and intra-frame signals](#)

1994

- > Developed world's first Digital Video Disc (DVD), key DVD enabling technology
- > Patent: [Method and apparatus for the transmission and reception of a multicarrier digital television signal](#)

1993

- > Patent: [Method and apparatus for digitally processing a high definition television augmentation signal](#)

1992

- > Patent: [Method and apparatus for the transmission and reception of a multicarrier digital television signal](#)
- > Patent: [Method and apparatus from transmitting augmentation panel components on one channel of a two channel wide aspect ratio television signal transmission](#)
- > Patent: [Decomposition and recombination of a wide-aspect ratio image](#)
- > Patent: [Two-line MAC high definition television system](#)
- > Patent: [System for providing a high definition television \(HDTV\) augmentation channel comprising time and frequency multiplexed components](#)

1991

- > Developed world's first Digital Consumer HDTV VCR (DVCR)
- > Senior Manager, Toshiba America Consumer Products, Advanced TV Technology Center
- > Patent: [Method and apparatus for demodulating chrominance signals using a training signal in place of a color burst signal](#)
- > Patent: [Method and apparatus for the transmission and reception multicarrier high definition television signal](#)
- > Patent: [High definition multiple analog component amplitude modulated television transmission system](#)
- > Patent: [High definition NTSC compatible television system with increased horizontal bandwidth and reduced color artifacts](#)
- > Patent: [HDNTSC transmission and reception with time and frequency multiplexing](#)

1990

- > Patent: [Adaptive comb filter for artifact-free decoding](#)
- > Patent: [HDNTSC channel with frequency multiplexing](#)
- > Patent: [Apparatus for encoding television signals of different formats for transmission and decoding upon reception](#)
- > Patent: [Training signal for maintaining the correct phase and gain relationship between signals in a two-signal high definition television system](#)
- > Patent: [HDNTSC channel with time and frequency multiplexing](#)
- > Patent: [Method and apparatus for introducing a pan and scan feature to high definition television systems](#)
- > Patent: [Two-line mac high definition television system](#)
- > Patent: [Method and apparatus for recombining a main panel component with a augmentation panel component to create a wide aspect ratio television display](#)

1989

- > Patent: [High definition television augmentation channel](#)
- > Patent: [Extended horizontal resolution of luminance and chrominance in a high definition television system](#)
- > Patent: [Adaptive comb filter for artifact-free decoding](#)
- > Patent: [Scan rate conversion apparatus and method](#)

1988

- > Patent: [High-definition television transmission system](#)
- > Patent: [Method and apparatus for transmitting and receiving a high definition NTSC compatible television signal over a single DBS channel](#)

1987

- > Developed first high-defintion television transmission system
- > Patent: [High-definition television transmission system](#)

Sales Contacts

U.S. Inquiries

Scott Pecchia

Vice President of Sales

- > Phone: 914-667-9700 ext 219
- > Mobile: 732.672.5508
- > Email: scott@keydigital.com

Jason Yourgules

Director of Sales, Central and West Coast

- > Phone: 914-667-9700 ext 218
- > Mobile: 832.703.4975
- > Email: jason.yourgules@keydigital.com

Leon Tsinberg

Eastern Regional Sales Manager

- > Phone: 914-667-9700 ext 215
- > Mobile: 646.228.0976
- > Email: leon@keydigital.com

International Sales Inquiries

Key Digital Europe

Oslo, Norway

- > Phone: +47 90 25 01 00
- > Email: sales@keydigitaleurope.eu

Abhinav Saxena

Country Head Asia Pacific Region

- > Phone: +91-9953-24-0867
- > Email: Abhinav.Saxena@keydigital.com

Michael Lakhter

Chief Business Development Officer

- > Phone: 914-667-9700 ext 210
- > Mobile: 917-653-0202
- > Email: michael@keydigital.com



To become an Authorized Key Digital® Reseller:

Please contact Key Digital Sales Department for a Reseller Package:

- > Phone: **914-667-9700 ext 2**
- > Email: sales@keydigital.com

General Contacts

System Design Group (SDG)

For system design questions please contact us at:

- > Phone: 914-667-9700 ext. 3
- > E-mail: sdg@keydigital.com

Key Digital Trainings

For questions about Key Digital Trainings please contact us at:

- > Phone: 914-667-9700 ext. 6
- > E-mail: training@keydigital.com

Customer Support

For customer support questions please contact us at:

- > Phone: 914-667-9700 ext. 7
- > E-mail: customersupport@keydigital.com

Technical Support

For technical questions about using Key Digital® products, please contact us at:

- > Phone: 914-667-9700 ext. 3
- > E-mail: tech@keydigital.com

Marketing and Public Relations:

For marketing and public relations information, please contact us at:

- > Phone: 914-667-9700 ext. 6
- > E-mail: marketing@keydigital.com

Shipping

For shipping questions please contact us at:

- > Phone: 914-667-9700 ext. 7
- > E-mail: shipping@keydigital.com

Accounting:

For accounting questions please contact us at:

- > Phone: 914-667-9700 ext. 5
- > E-mail: accounting@keydigital.com

Repairs and Warranty Service

Should your product require warranty service or repair, please obtain a Key Digital® Return Material Authorization (RMA) number by contacting us at:

- > Phone: 914-667-9700 ext. 4
- > E-mail: rma@keydigital.com

Key digital[®]

521 East 3rd Street :: Mount Vernon, NY 10553

Phone : 914.667.9700 :: www.keydigital.com